



**Opto Plus LED Corp.**  
**0.30" SMD Type LED Display**  
**OPS-T3010LB-GW**  
**OPS-T3011LB-GW**

● **FEATURES**

- 0.30 inch (7.62 mm) Digit Height.
- SMD type.
- Low current operation.
- Gray face, White segment.
- RoHS compliant, Pb Free.

● **DESCRIPTION**

The OPS-T3010LB-GW & OPS-T3011LB-GW are 0.30 inch (7.62mm) height Triple 7-segment displays.

This device utilizes Super Bright Blue LED chip which are made from InGaN On a transparent GaN, substrate.

The display has Gray face, White segment.

● **DEVICE**

PART NO	DESCRIPTION
OPS-T3010LB-GW	Common Anode
OPS-T3011LB-GW	Common Cathode

**RoHS Compliance**



**Pb free.**



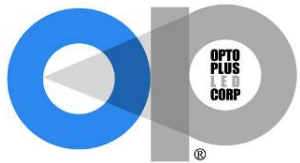

# Opto Plus LED Corp.

## 0.30" SMD Type LED Display

### OPS-T3010LB-GW

### OPS-T3011LB-GW

#### ● MECHANICAL DIMENSIONS

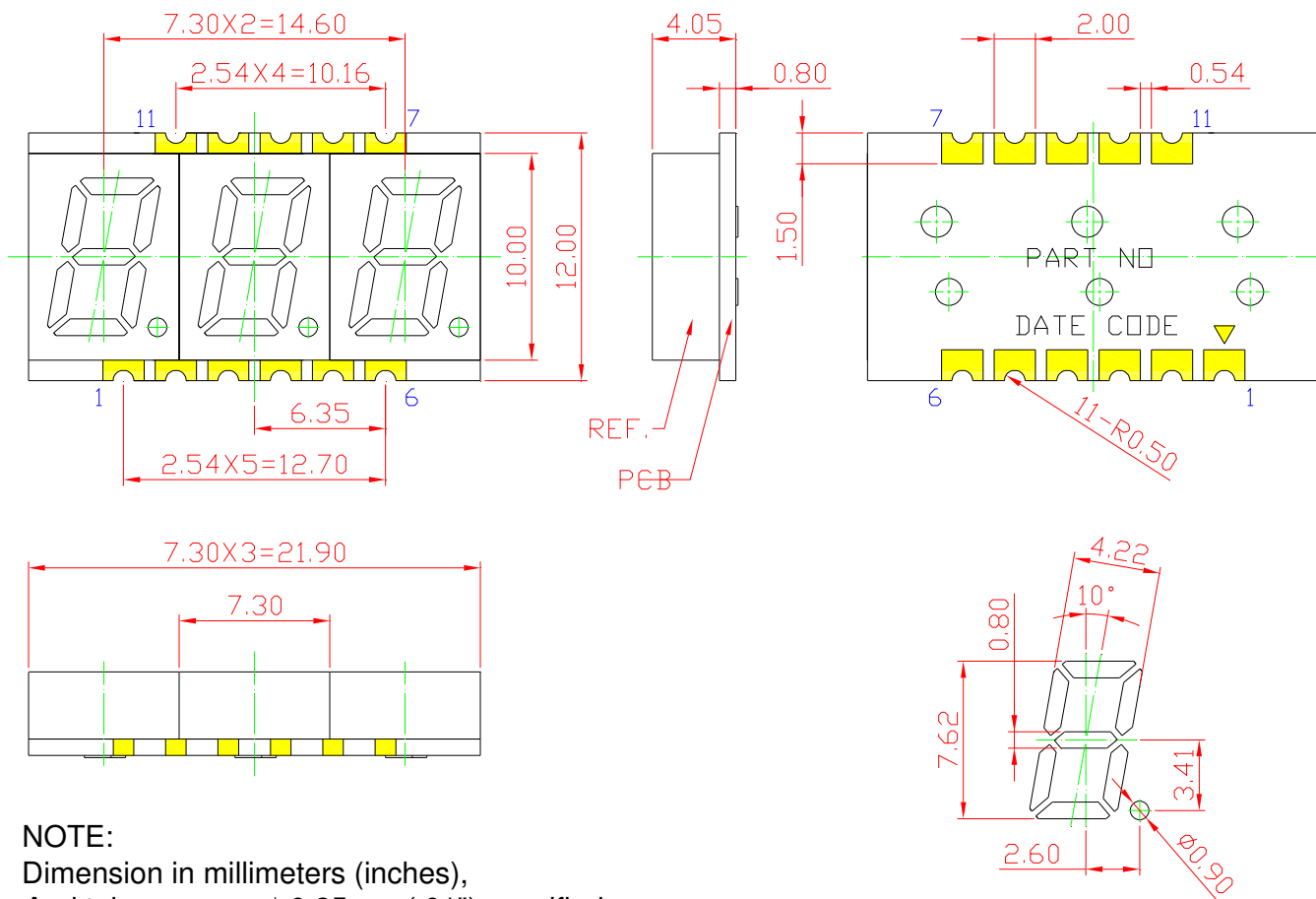

**NOTE:**  
 Dimension in millimeters (inches),  
 And tolerance are  $\pm 0.25\text{mm}$  (.01") specified.

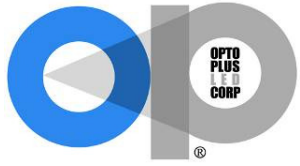

# Opto Plus LED Corp.

## 0.30" SMD Type LED Display

### OPS-T3010LB-GW

### OPS-T3011LB-GW

#### ● TYPICAL INTERNAL EQUIVALENT CIRCUIT

Recommended  
Soldering Pattern

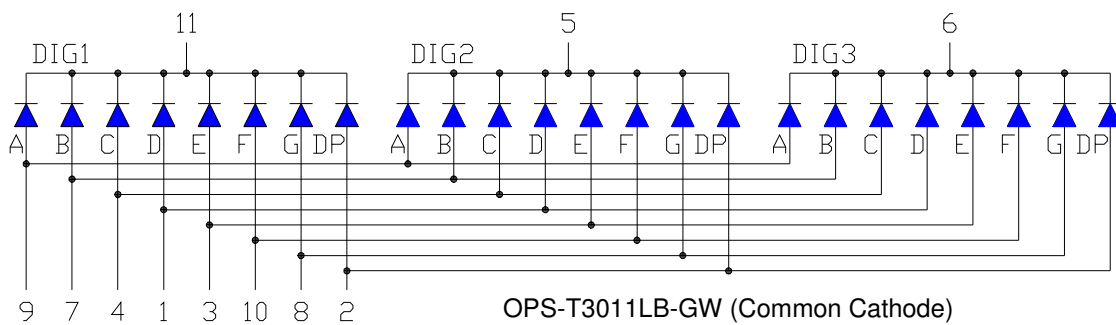
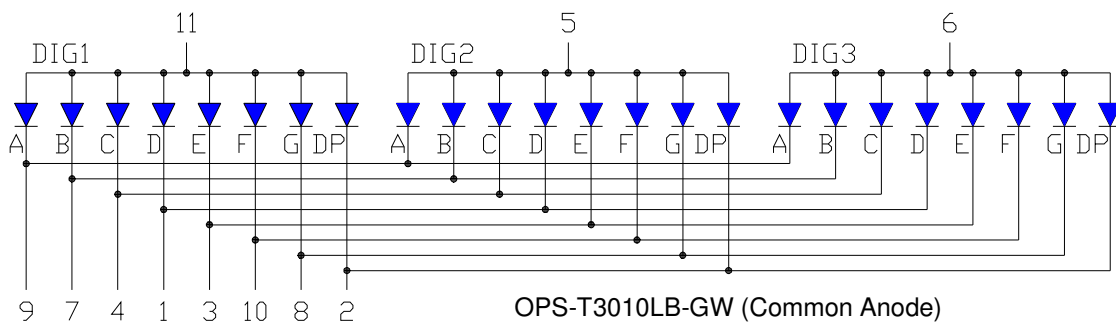
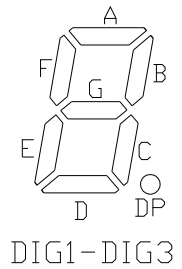
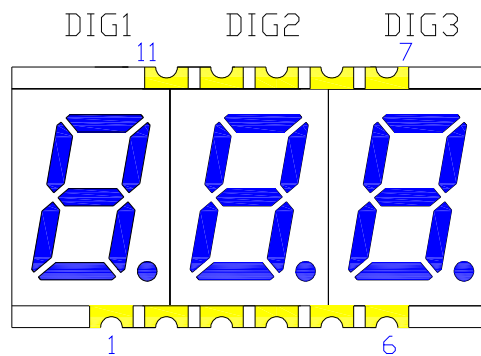
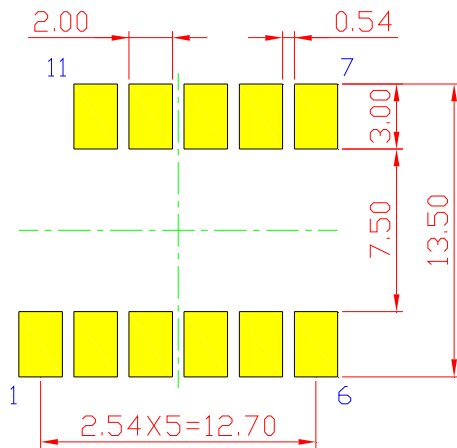



**Opto Plus LED Corp.**  
**0.30'' SMD Type LED Display**  
**OPS-T3010LB-GW**  
**OPS-T3011LB-GW**

● **LB: SUPER BRIGHT BLUE (InGaN/GaN)**

ABSOLUTE MAXIMUM RATING AT  $T_a=25^{\circ}\text{C}$

Parameter	Symbol	Maximum Rating	Unit
Power dissipation	$P_{AD}$	120	mW
Derating liner from 25°C	-	0.3	mA / °C
Continuous forward current	$I_{AF}$	30	mA
Peak current (duty cycle 1/10, 1kHz)	$I_{PF}$	100	mA
Reverse voltage	$V_R$	5	V
Operating temperature	$T_{OPR}$	-40 to +105	°C
Storage temperature	$T_{STG}$	-40 to +105	°C

ELECTRICAL - OPTICAL CHARACTERISTICS AT  $T_a=25^{\circ}\text{C}$

Characteristic	Symbol	Condition	Min.	Type.	Max.	Unit
Forward Voltage, (Per Dice)	$V_F$	$I_F=20\text{mA}$	-	3.2	4.0	V
Reverse Current, (Per Dice)	$I_R$	$V_R=8\text{V}$	-	-	10	$\mu\text{A}$
Dominant Wavelength	$\lambda_D$	$I_F=20\text{mA}$	-	470	-	nm
Luminous Intensity	$I_V$	$I_F=20\text{mA}$	-	10	-	mcd
Spectral radiation bandwidth	$\Delta\lambda$	$I_F=20\text{mA}$	-	30	-	nm



# Opto Plus LED Corp.

## 0.30" SMD Type LED Display

### OPS-T3010LB-GW

### OPS-T3011LB-GW

#### ● LB: SUPER BRIGHT BLUE (InGaN/GaN) CURVE

Typical Electro-optical Characteristic Curves  
(25 °C Free Air Temperature Unless Otherwise Specified)

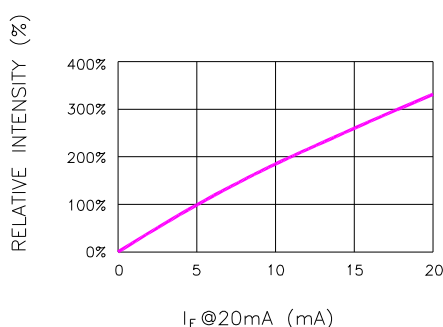

Fig.1 RELATIVE INTENSITY VS. FORWARD CURRENT

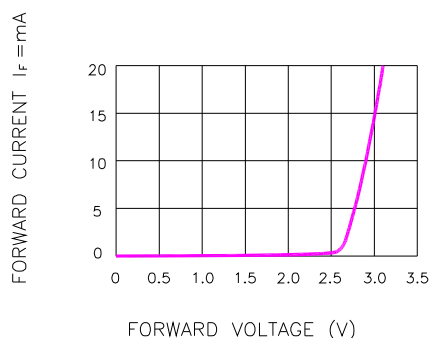

Fig.2 FORWARD CURRENT VS. FORWARD VOLTAGE

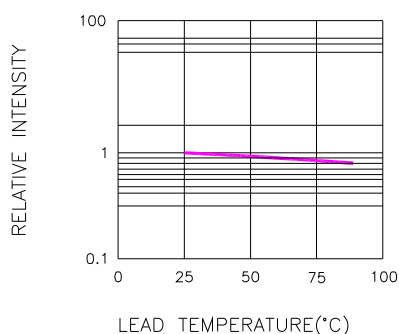

Fig.3 RELATIVE INTENSITY VS. LEAD TEMPERATURE  
(PULSED 20 mA; 300us PULSE, 10ms PERIOD)

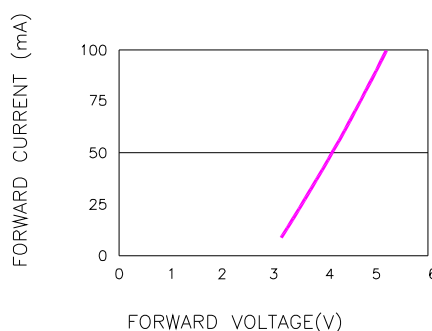

Fig.4 PEAK FORWARD VOLTAGE VS. FORWARD (100us TEST PULSE, 1% DUTY CYCLE)

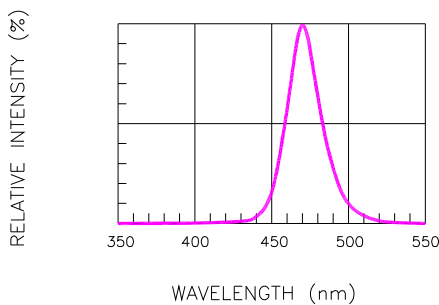

Fig.5 RELATIVE INTENSITY VS. WAVELENGTH

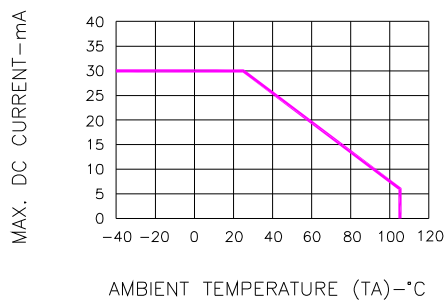
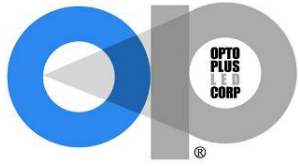

Fig.6 MAX. ALLOWABLE DC CURRENT VS. AMBIENT TEMPERATURE



**Opto Plus LED Corp.**  
**0.30" SMD Type LED Display**  
**OPS-T3010LB-GW**  
**OPS-T3011LB-GW**

● **RECOMMEND SOLDERING PROFILE**

SMT Soldering Profile

Pb free reflow soldering Profile

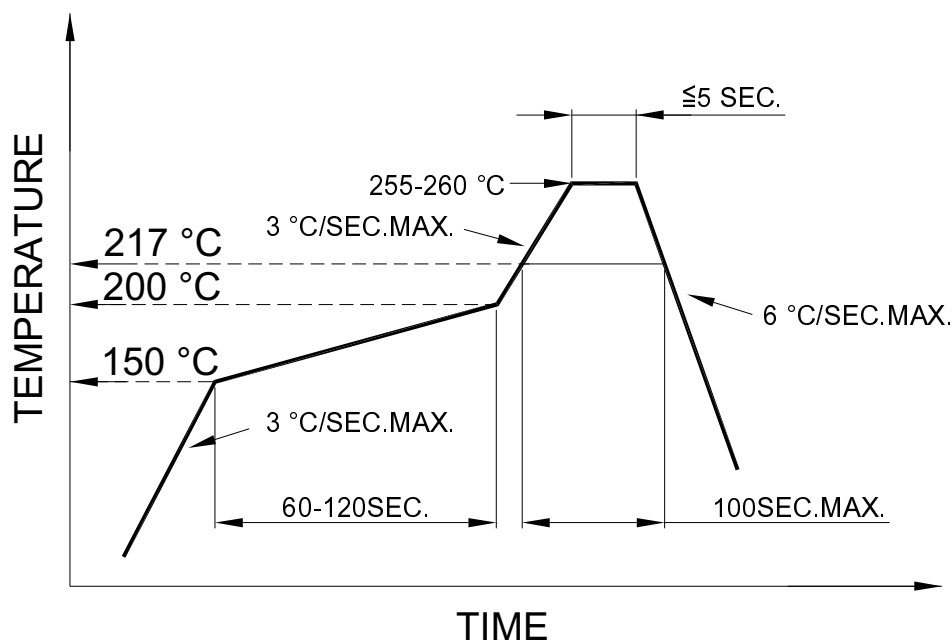

● **SOLDERING IRON**

Basic specification :  $\leq 4$  seconds when 260°C, If temperature is higher, time should be shorter (+10°C→1 sec). Power dissipation of iron should be smaller than 15W, and temperature should be controllable. Surface temperature of the device should be under 230°C.

● **REWORK**

Customer must finish rework within  $\leq 3$  sec under 350°C.