



Opto Plus LED Corp.
0.56" SMD Type LED Display
OPS-S5620SPG-GW
OPS-S5621SPG-GW

● **EDIT HISTORY**

Version A: Oct. 21, 2015

Preliminary spec.

Manufacture	Examination	Approving



Opto Plus LED Corp.
0.56" SMD Type LED Display
OPS-S5620SPG-GW
OPS-S5621SPG-GW

● **FEATURES**

- 0.56 inch (14.20 mm) Digit Height.
- SMD type.
- Low current operation.
- Gray face, White segment.
- RoHS compliant, Pb Free.

● **DESCRIPTION**

The OPS-S5620SPG-GW & OPS-S5621SPG-GW are 0.56 inch (14.20 mm) height Single digit 7-segment displays.

This device utilizes Pure Green chip which are made from InGaN on a transparent GaN, substrate.

The display has Gray face, White segment.

● **DEVICE**

PART NO	DESCRIPTION
OPS-S5620SPG-GW	Common Anode
OPS-S5621SPG-GW	Common Cathode

RoHS Compliance



Pb free.





Opto Plus LED Corp.
0.56" SMD Type LED Display
OPS-S5620SPG-GW
OPS-S5621SPG-GW

● **MECHANICAL DIMENSIONS**

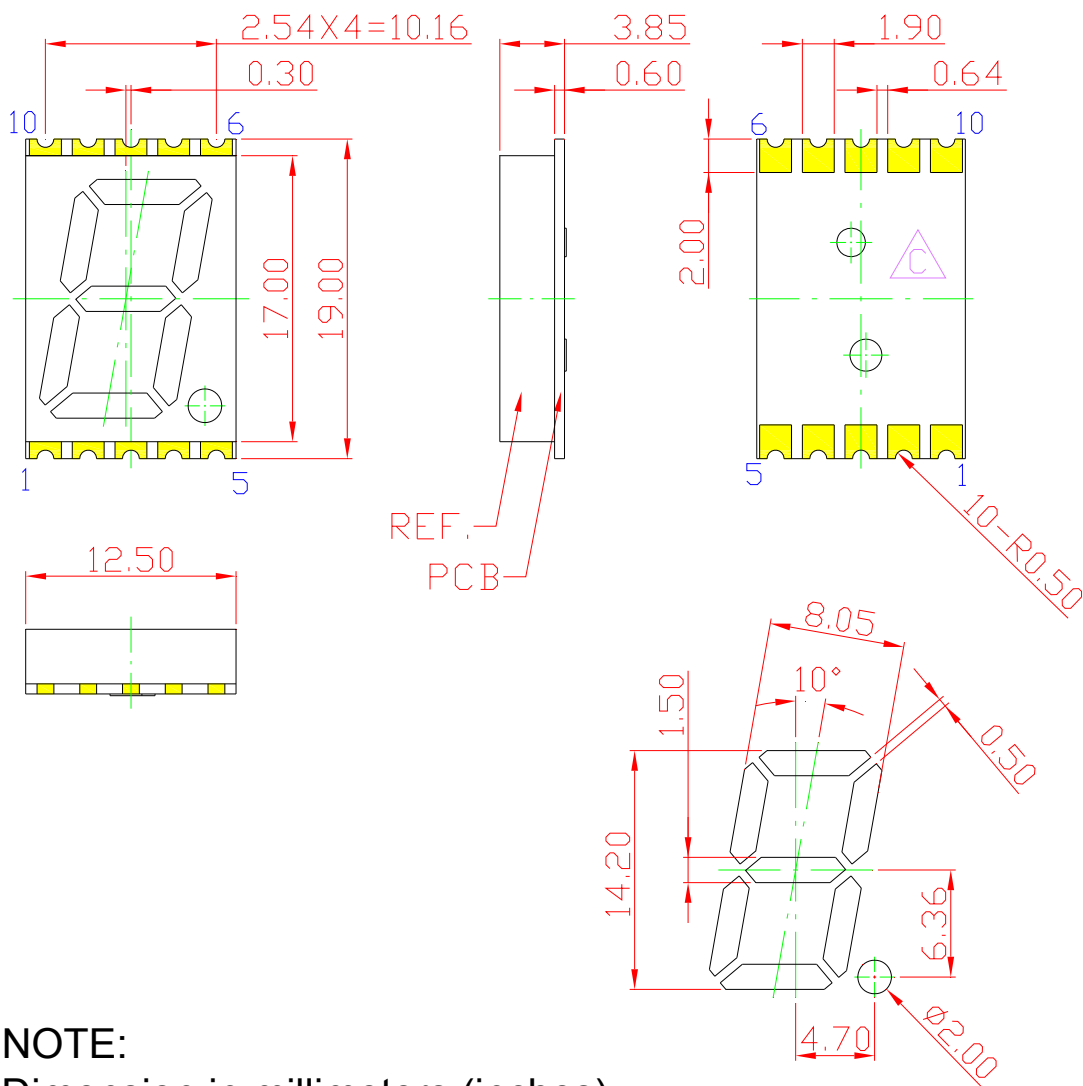

NOTE:
 Dimension in millimeters (inches),
 and tolerances are $\pm 0.25\text{mm}$ (.01") specified.



Opto Plus LED Corp.
0.56" SMD Type LED Display
OPS-S5620SPG-GW
OPS-S5621SPG-GW

● **TYPICAL INTERNAL EQUIVALENT CIRCUIT**

Recommended Soldering Pattern

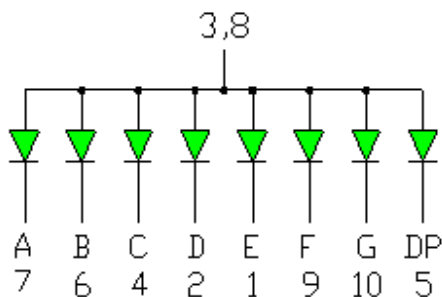
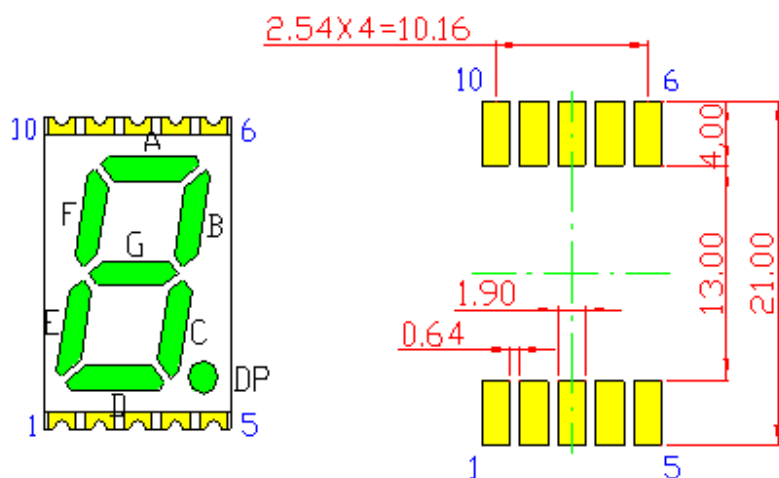

OPS-S5620SPG-GW
(Common Anode)

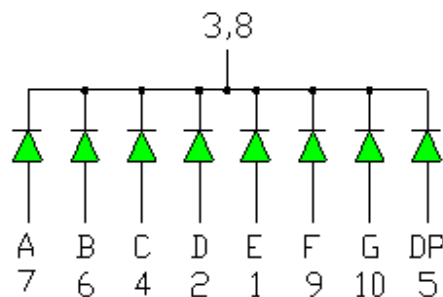

OPS-S5621SPG-GW
(Common Cathode)



Opto Plus LED Corp.
0.56'' SMD Type LED Display
OPS-S5620SPG-GW
OPS-S5621SPG-GW

● **SPG: PURE GREEN (InGaN/GaN)**

ABSOLUTE MAXIMUM RATING AT Ta=25°C

Parameter	Symbol	Maximum Rating	Unit
Power dissipation	P _{AD}	120	mW
Derating liner from 25°C	-	0.3	mA / °C
Continuous forward current	I _{AF}	30	mA
Peak current (duty cycle 1/10, 1kHz)	I _{PF}	100	mA
Reverse voltage	V _R	5	V
Operating temperature	T _{OPR}	-40 to +105	°C
Storage temperature	T _{STG}	-40 to +105	°C

ELECTRICAL - OPTICAL CHARACTERISTICS AT Ta=25°C

Characteristic	Symbol	Condition	Min.	Type.	Max.	Unit
Forward Voltage, (Per Dice)	V _F	I _F = 20mA	-	3.0	4.0	V
Reverse Current, (Per Dice)	I _R	V _R = 8V	-	-	10	μA
Dominant Wavelength	λ _D	I _F = 20mA	515	-	530	nm
Luminous Intensity	I _v	I _F = 20mA	-	200	-	mcd
Spectral radiation bandwidth	Δλ	I _F = 20mA	-	30	-	nm

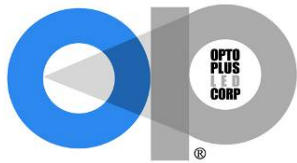

Opto Plus LED Corp.

0.56" SMD Type LED Display

OPS-S5620SPG-GW

OPS-S5621SPG-GW

● SPG: PURE GREEN (InGaN/GaN) CURVE

Typical Electro-optical Characteristic Curves
(25 °C Free Air Temperature Unless Otherwise Specified)

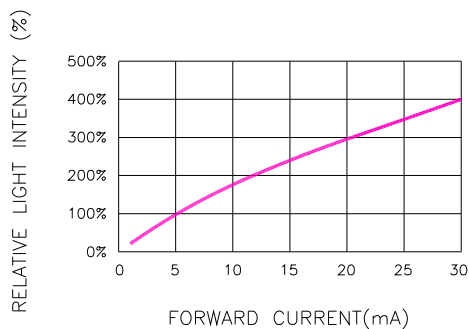

Fig.1 RELATIVE LIGHT INTENSITY VS. FORWARD CURRENT

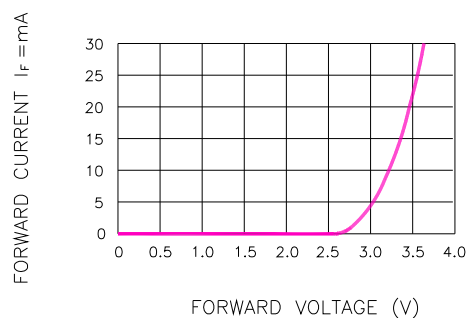

Fig.2 FORWARD CURRENT VS. FORWARD VOLTAGE

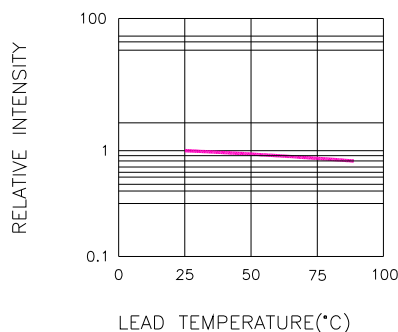

Fig.3 RELATIVE INTENSITY VS. LEAD TEMPERATURE
(PULSED 20 mA; 300us PULSE, 10ms PERIOD)

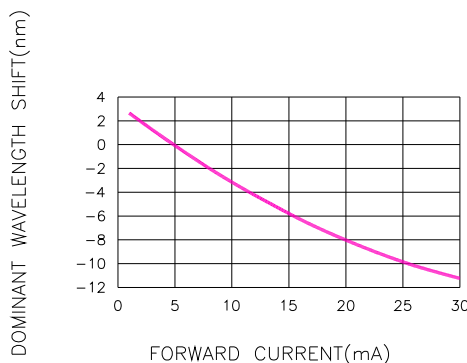

Fig.4 DOMINANT WAVELENGTH SHIFT VS. FORWARD CURRENT

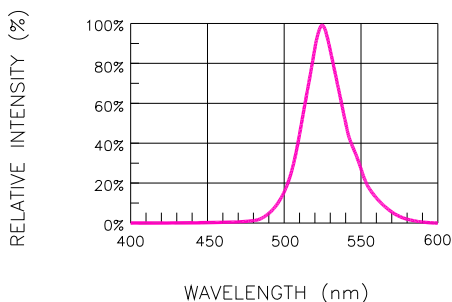

Fig.5 RELATIVE INTENSITY VS. WAVELENGTH

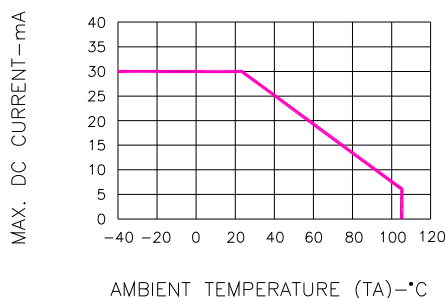

Fig.6 MAX. ALLOWABLE DC CURRENT VS. AMBIENT TEMPERATURE



Opto Plus LED Corp.
0.56" SMD Type LED Display
OPS-S5620SPG-GW
OPS-S5621SPG-GW

● **SMT REFLOW SOLDERING INSTRUCTIONS**

SMT Soldering Profile

Pb free reflow soldering Profile

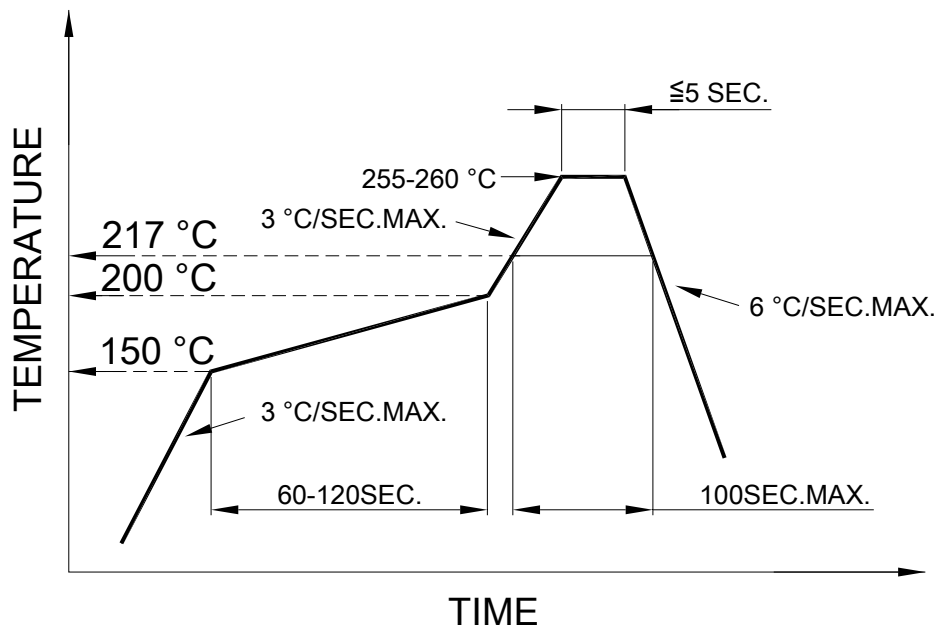

- We recommend the reflow temperature 245°C (+/- 5°C).
The maximum soldering temperature should be limited to 260°C.
- Number of reflow process shall be 2 times or less.

● **SOLDERING IRON**

Basic spec is ≤ 4 sec when 260°C. If temperature is higher, time should be shorter (+10°C → 1 sec). Power dissipation of Iron should be smaller than 15W, and temperature should be controllable. Surface temperature of the device should be under 230°C.

● **REWORK**

- Customer must finish rework within 3 sec. under 350°C.
- The head of soldering iron cannot touch copper foil.

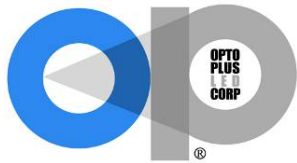

Opto Plus LED Corp.
0.56" SMD Type LED Display
OPS-S5620SPG-GW
OPS-S5621SPG-GW

● **REEL DIMENSIONS**

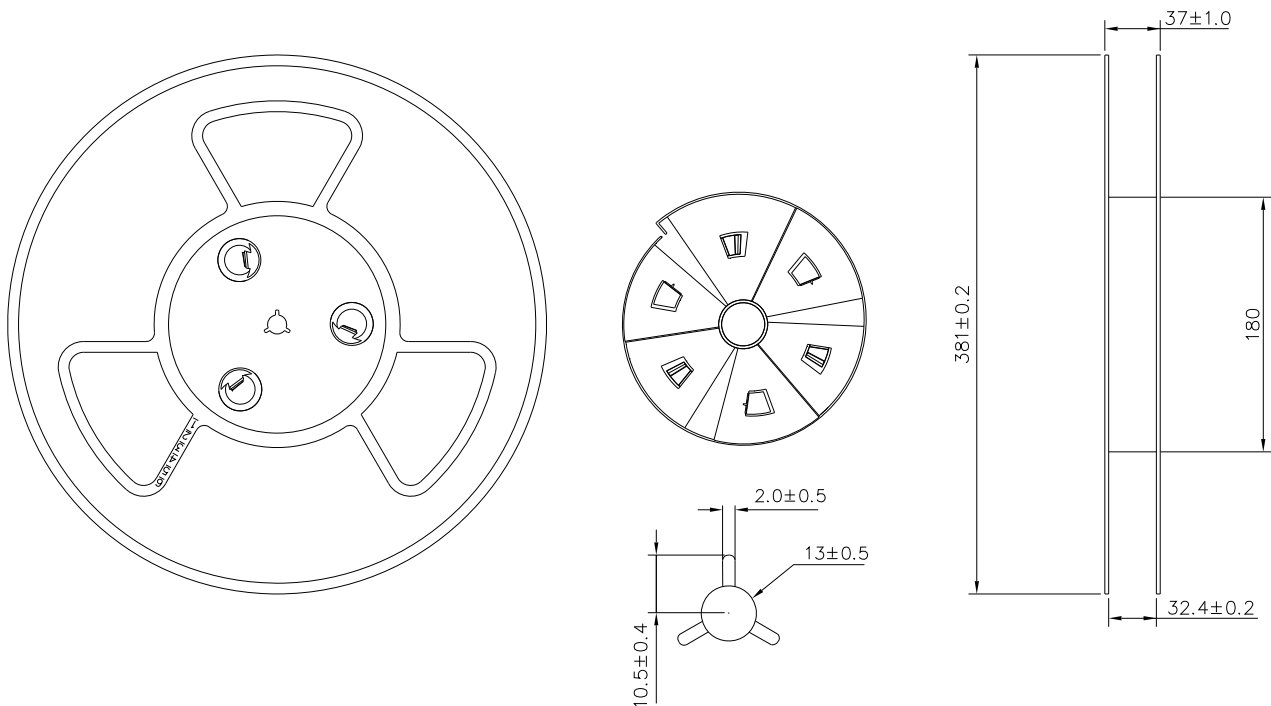

● **PACKING & LABEL SPECIFICATIONS**

