



Opto Plus LED Corp.
0.28" SMD Type LED Display
OPS-S2812LR-GW
OPS-S2811LR-GW

● **EDIT HISTORY**

Version A: Jan. 08, 2013

Preliminary spec.

Version B: Apr. 07, 2015

Add package pec.

Version C: Oct. 28, 2015

1. Modify mechanical dimensions.

2. Add bin & hue data.

| Manufacture | Examination | Approving |
|-------------|-------------|-----------|
| | | |

Version: C Date: 10/28/2015

Opto Plus LED Corp. 7F-3, No.496, Bannan Road, Jhonghe Dist., New Taipei City 235, Taiwan (R.O.C)

Website: www.opled.com.tw E-mail: sales@opled.com.tw Tel: 886-2-2222-5698 Fax: 886-2-2222-2566



Opto Plus LED Corp.
0.28" SMD Type LED Display
OPS-S2812LR-GW
OPS-S2811LR-GW

● **FEATURES**

- 0.28 inch (7.00 mm) Digit Height.
- SMD type.
- Low current operation.
- Gray face, White segment.
- RoHS compliant, Pb Free.

● **DESCRIPTION**

The OPS-S2811LR-GW & OPS-S2812LR-GW are 0.28 inch (7.00 mm) height Single digit 7-segment display.

This device utilizes Super Red LED chip which are made from AlGaInP on a Transparent GaAs, substrate.

The display has Gray face, White segment.

● **DEVICE**

| PART NO | DESCRIPTION |
|----------------|----------------|
| OPS-S2812LR-GW | Common Anode |
| OPS-S2811LR-GW | Common Cathode |

RoHS Compliance



Pb free.



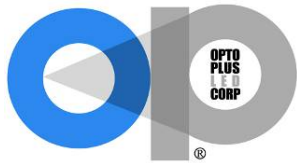

Opto Plus LED Corp.
0.28" SMD Type LED Display
OPS-S2812LR-GW
OPS-S2811LR-GW

● **MECHANICAL DIMENSIONS**

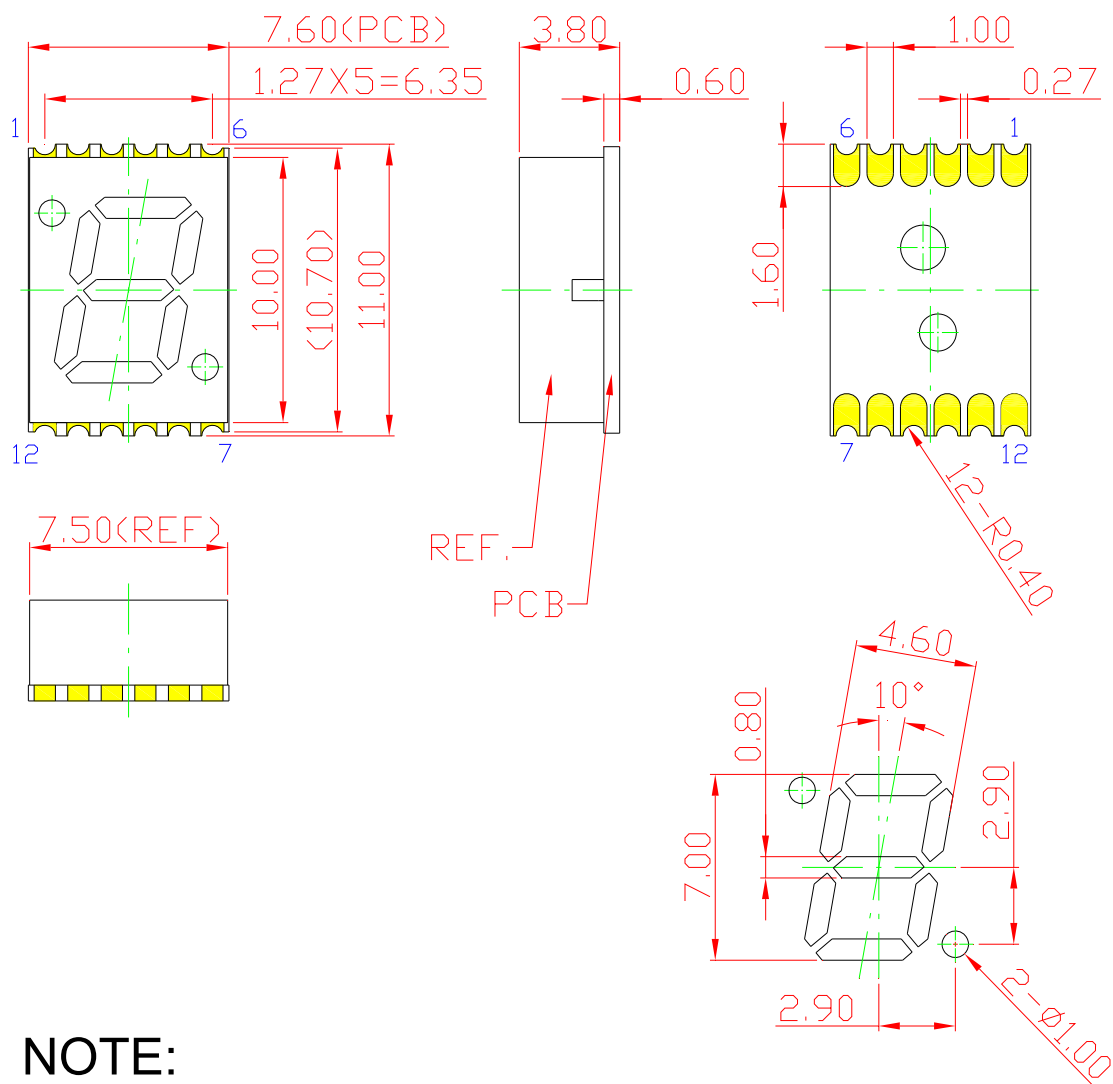

NOTE:
 Dimension in millimeters (inches),
 and tolerances are $\pm 0.25\text{mm}$ (.01") specified.



Opto Plus LED Corp.
0.28" SMD Type LED Display
OPS-S2812LR-GW
OPS-S2811LR-GW

● **TYPICAL INTERNAL EQUIVALENT CIRCUIT**

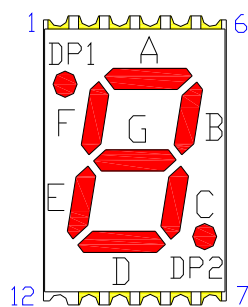

Recommended Soldering Pattern

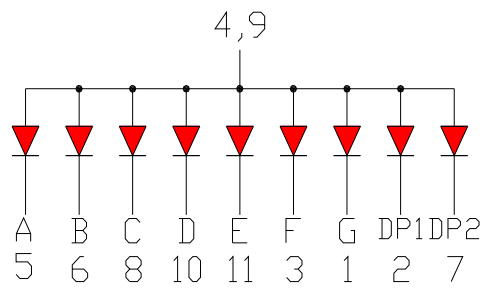
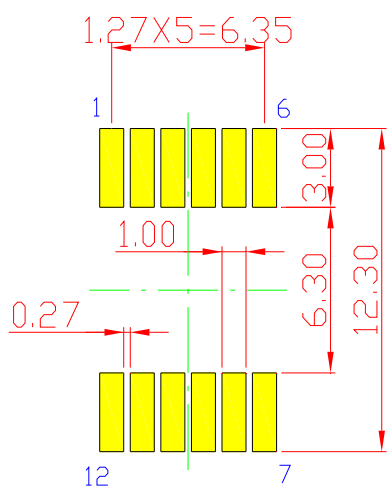

12 PIN No Connect
 OPS-S2812LR-GW
 (Common Anode)

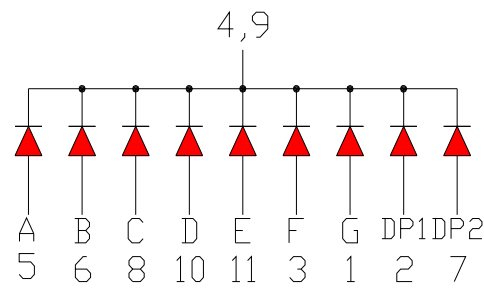

12 PIN No Connect
 OPS-S2811LR-GW
 (Common Cathode)



Opto Plus LED Corp.
0.28'' SMD Type LED Display
OPS-S2812LR-GW
OPS-S2811LR-GW

● **LR: SUPER RED (AlGaInP/GaAs)**

ABSOLUTE MAXIMUM RATING AT Ta=25°C

| Parameter | Symbol | Maximum Rating | Unit |
|--------------------------------------|-----------|----------------|---------|
| Power dissipation | P_{AD} | 75 | mW |
| Derating liner from 25°C | - | 0.3 | mA / °C |
| Continuous forward current | I_{AF} | 30 | mA |
| Peak current (duty cycle 1/10, 1kHz) | I_{PF} | 100 | mA |
| Reverse voltage | V_R | 5 | V |
| Operating temperature | T_{OPR} | -40 to +105 | °C |
| Storage temperature | T_{STG} | -40 to +105 | °C |

ELECTRICAL - OPTICAL CHARACTERISTICS AT Ta=25°C

| Characteristic | Symbol | Condition | Min. | Type. | Max. | Unit |
|------------------------------|-----------------|---------------------|------|-------|------|---------------|
| Forward Voltage, (Per Dice) | V_F | $I_F = 20\text{mA}$ | - | 2.0 | 2.6 | V |
| Reverse Current, (Per Dice) | I_R | $V_R = 5\text{V}$ | - | - | 10 | μA |
| Peak Wavelength | λ_P | $I_F = 20\text{mA}$ | - | 650 | - | nm |
| Dominant Wavelength | λ_D | $I_F = 20\text{mA}$ | 636 | 640 | 646 | nm |
| Luminous Intensity | I_v | $I_F = 20\text{mA}$ | 0.5 | - | 12 | mcd |
| Spectral radiation bandwidth | $\Delta\lambda$ | $I_F = 20\text{mA}$ | - | 20 | - | nm |

Version: C Date: 10/28/2015

Opto Plus LED Corp. 7F-3, No.496, Bannan Road, Zhonghe Dist., New Taipei City 235, Taiwan (R.O.C)

Website: www.opled.com.tw E-mail: sales@opled.com.tw Tel: 886-2-2222-5698 Fax: 886-2-2222-2566



Opto Plus LED Corp.
0.28" SMD Type LED Display
OPS-S2812LR-GW
OPS-S2811LR-GW

● LR: BIN GRADE (Unit : mcd) 20mA

| Super Red | F | G | H |
|-----------|-----------|-----------|------------|
| | 0.5 – 4.0 | 4.1 – 8.0 | 8.1 – 12.0 |

● LR: HUE GRADE (λ_D : nm)

| 1 | 2 | 3 |
|---------------|---------------|---------------|
| 636.0 – 639.0 | 639.1 – 643.0 | 643.1 – 646.0 |

● AVAILABLE BIN / HUE TABLE

| | | |
|----|----|----|
| F1 | G1 | H1 |
| F2 | G2 | H2 |
| F3 | G3 | H3 |



Opto Plus LED Corp.

0.28" SMD Type LED Display

OPS-S2812LR-GW

OPS-S2811LR-GW

● LR: SUPER RED (AlGaInP/GaAs) CURVE

Typical Electro-optical Characteristic Curves
(25 °C Free Air Temperature Unless Otherwise Specified)

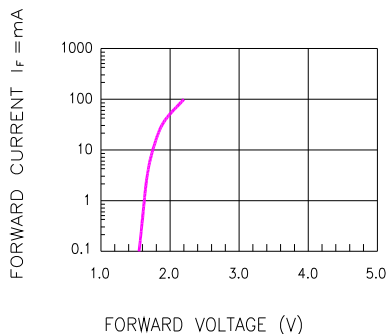

Fig.1 FORWARD CURRENT VS. FORWARD VOLTAGE

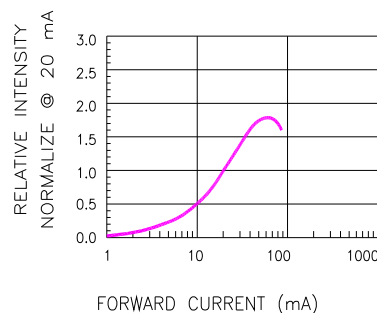

Fig.2 RELATIVE INTENSITY VS. FORWARD CURRENT

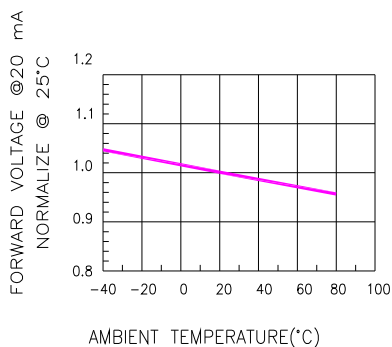

Fig.3 FORWARD VOLTAGE VS. TEMPERATURE

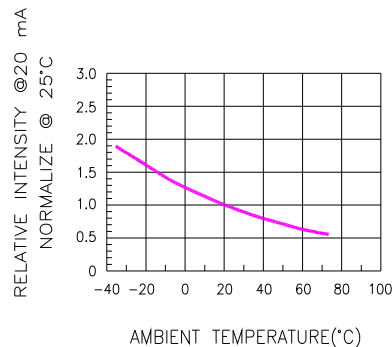

Fig.4 RELATIVE INTENSITY VS. TEMPERATURE

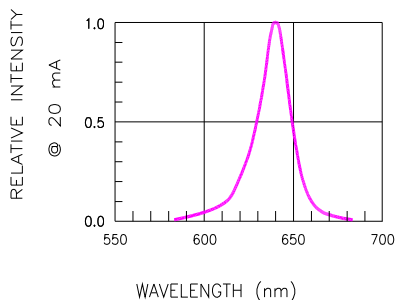

Fig.5 RELATIVE INTENSITY VS. WAVELENGTH

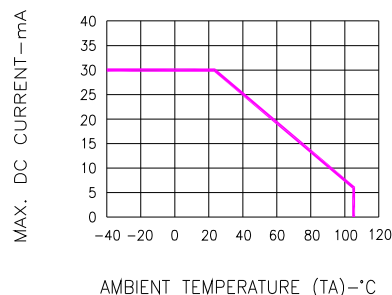

Fig.6 MAX. ALLOWABLE DC CURRENT VS. AMBIENT TEMPERATURE

Version: C Date: 10/28/2015

Opto Plus LED Corp. 7F-3, No.496, Bannan Road, Zhonghe Dist., New Taipei City 235, Taiwan (R.O.C)

Website: www.opled.com.tw E-mail: sales@opled.com.tw Tel: 886-2-2222-5698 Fax: 886-2-2222-2566



Opto Plus LED Corp.
0.28" SMD Type LED Display
OPS-S2812LR-GW
OPS-S2811LR-GW

● **RECOMMEND SOLDERING PROFILE**

SMT Soldering Profile

Pb free reflow soldering Profile

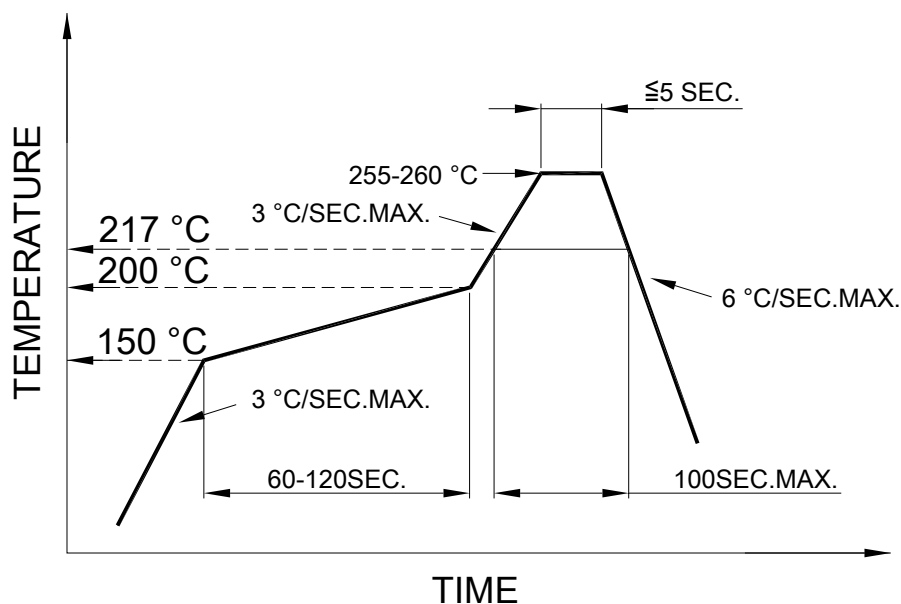

- We recommend the reflow temperature 245°C (+/- 5°C).
The maximum soldering temperature should be limited to 260°C.
- Number of reflow process shall be 2 times or less.

● **SOLDERING IRON**

Basic spec is ≤ 4 sec when 260°C. If temperature is higher, time should be shorter (+10°C → 1 sec). Power dissipation of Iron should be smaller than 15W, and temperature should be controllable. Surface temperature of the device should be under 230°C.

● **REWORK**

- Customer must finish rework within 3 sec. under 350°C.
- The head of soldering iron cannot touch copper foil.

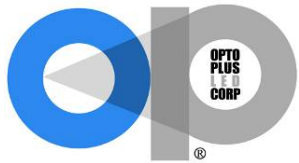

Opto Plus LED Corp.

0.28" SMD Type LED Display

OPS-S2812LR-GW

OPS-S2811LR-GW

● REEL DIMENSIONS

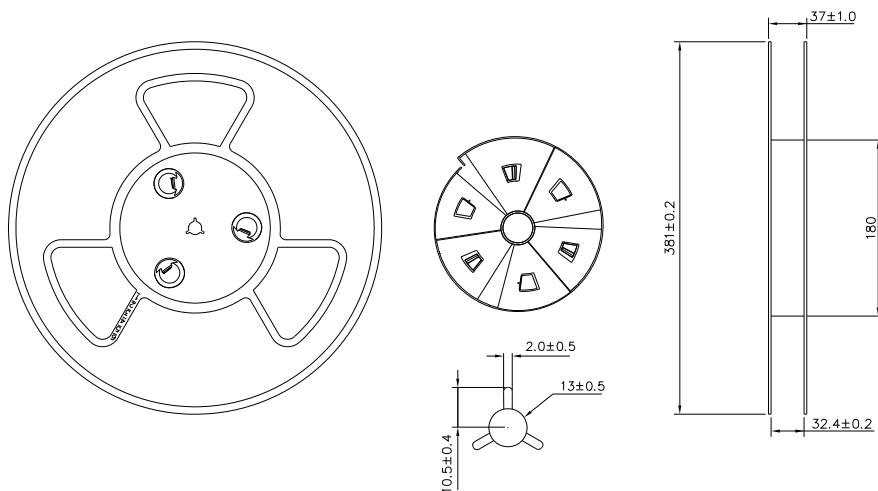

● PACKING & LABEL SPECIFICATIONS

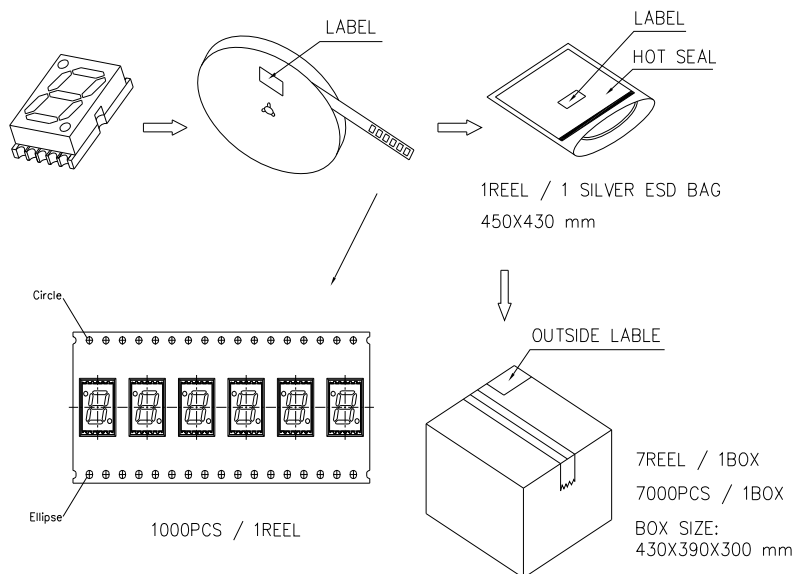

● STORAGE CONDITION

In factory original sealed bag package

| TEMPERATURE CONDITION | HUMIDITY CONDITION |
|-----------------------|--------------------|
| 5°C ~ 30°C | Below 60%RH |

After opened and not in factory original sealed bag package

| TEMPERATURE CONDITION | HUMIDITY CONDITION | STORAGE TIME |
|-----------------------|--------------------|----------------------------------|
| 5°C ~ 30°C | Below 60%RH | Within 4 weeks (MSL as level 2a) |

Version: C Date: 10/28/2015

Opto Plus LED Corp. 7F-3, No.496, Bannan Road, Zhonghe Dist., New Taipei City 235, Taiwan (R.O.C)

Website: www.opled.com.tw E-mail: sales@opled.com.tw Tel: 886-2-2222-5698 Fax: 886-2-2222-2566