



**Opto Plus LED Corp.**  
**0.28" SMD Type LED Display**  
**OPS-Q2810LY-GW**  
**OPS-Q2811LY-GW**

● **FEATURES**

- 0.28 inch (7.00 mm) Digit Height.
- SMD type.
- Low current operation.
- Gray face, White segment.
- RoHS compliant, Pb Free.

● **DESCRIPTION**

The OPS-Q2810LY-GW & OPS-Q2811LY-GW are 0.28 inch (7.00mm) height Quadruple 7-segment displays.

This device utilizes Super Bright Yellow LED chip which are made from AlGaInP On a transparent GaAs, substrate.

The display has Gray face, White segment.

● **DEVICE**

PART NO	DESCRIPTION
OPS-Q2810LY-GW	Common Anode
OPS-Q2811LY-GW	Common Cathode

**RoHS Compliance**



**Pb free.**



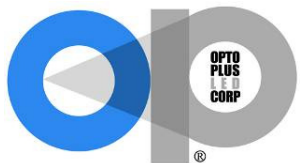

# Opto Plus LED Corp.

## 0.28" SMD Type LED Display

### OPS-Q2810LY-GW

### OPS-Q2811LY-GW

#### ● MECHANICAL DIMENSIONS

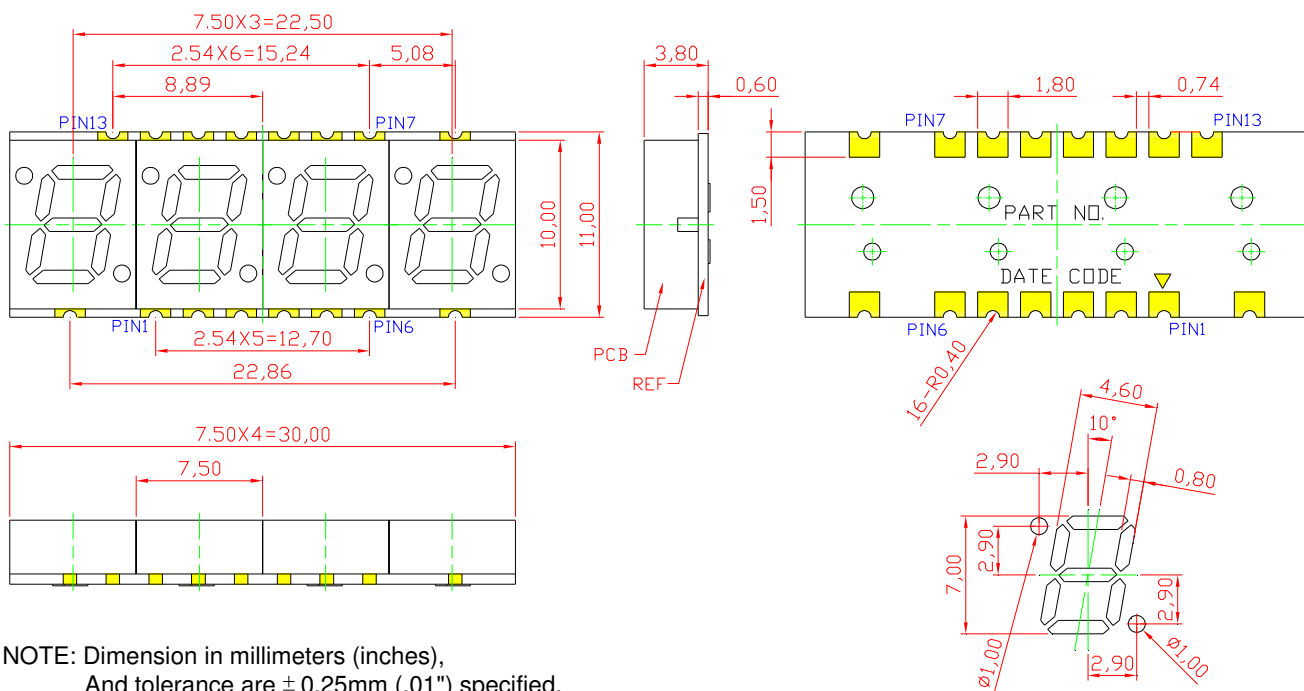

NOTE: Dimension in millimeters (inches),  
And tolerance are  $\pm 0.25\text{mm}$  (.01") specified.

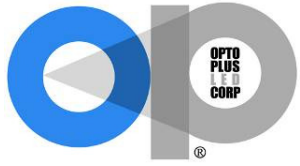

# Opto Plus LED Corp.

## 0.28" SMD Type LED Display

### OPS-Q2810LY-GW

### OPS-Q2811LY-GW

#### ● TYPICAL INTERNAL EQUIVALENT CIRCUIT

Recommended Soldering Pattern

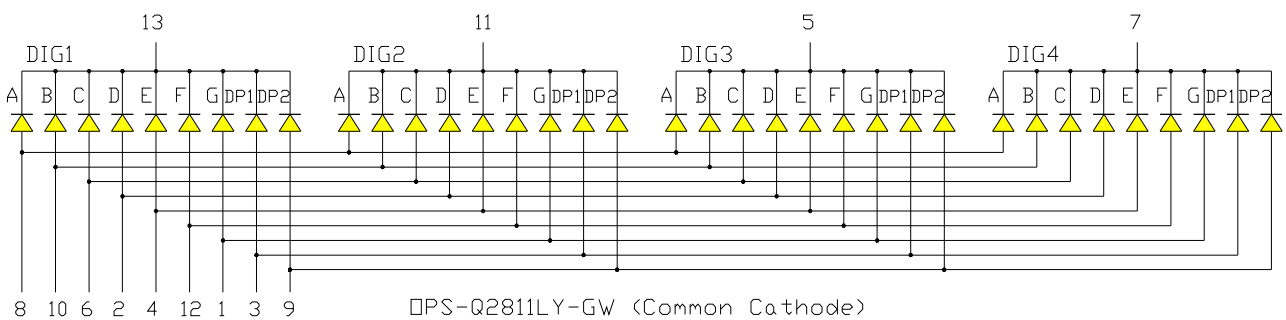
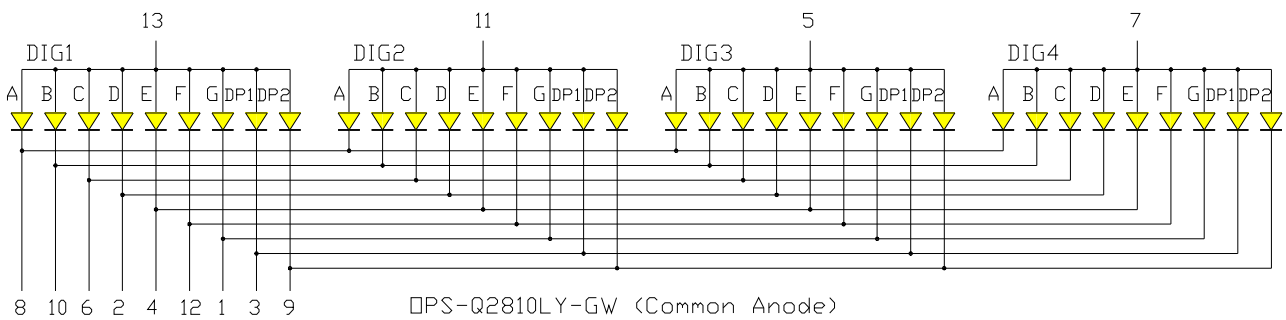
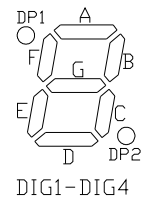
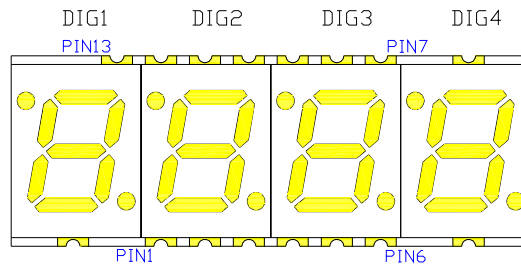
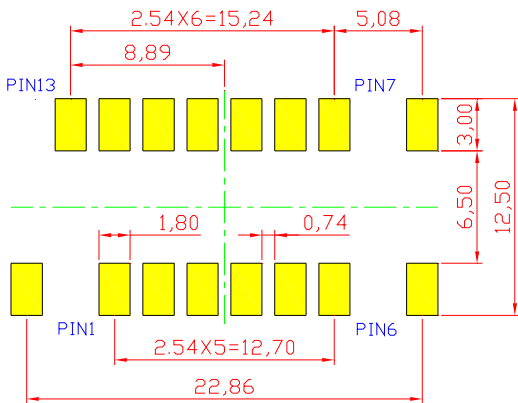



**Opto Plus LED Corp.**  
**0.28'' SMD Type LED Display**  
**OPS-Q2810LY-GW**  
**OPS-Q2811LY-GW**

● **LY: SUPER BRIGHT YELLOW (AlGaInP/GaAs)**

ABSOLUTE MAXIMUM RATING AT Ta=25°C

Parameter	Symbol	Maximum Rating	Unit
Power dissipation	P <sub>AD</sub>	70	mW
Derating liner from 25°C	-	0.28	mA / °C
Continuous forward current	I <sub>AF</sub>	25	mA
Peak current (duty cycle 1/10, 1kHz)	I <sub>PF</sub>	90	mA
Reverse voltage	V <sub>R</sub>	5	V
Operating temperature	T <sub>OPR</sub>	-40 to +105	°C
Storage temperature	T <sub>STG</sub>	-40 to +105	°C

ELECTRICAL - OPTICAL CHARACTERISTICS AT Ta=25°C

Characteristic	Symbol	Condition	Min.	Type.	Max.	Unit
Forward Voltage, (Per Dice)	V <sub>F</sub>	I <sub>F</sub> =20mA	-	2.0	2.6	V
Reverse Current, (Per Dice)	I <sub>R</sub>	V <sub>R</sub> =5V	-	-	10	μA
Peak Wavelength	λ <sub>P</sub>	I <sub>F</sub> =20mA	-	593	-	nm
Dominant Wavelength	λ <sub>D</sub>	I <sub>F</sub> =20mA	-	590	-	nm
Luminous Intensity	I <sub>V</sub>	I <sub>F</sub> =20mA	-	10	-	mcd
Spectral radiation bandwidth	Δλ	I <sub>F</sub> =20mA	-	20	-	nm



# Opto Plus LED Corp.

## 0.28" SMD Type LED Display

### OPS-Q2810LY-GW

### OPS-Q2811LY-GW

#### ● LY: SUPER BRIGHT YELLOW (AlGaInP/GaAs) CURVE

Typical Electro-optical Characteristic Curves  
(25 °C Free Air Temperature Unless Otherwise Specified)

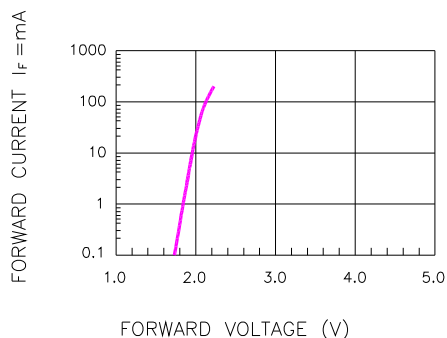

Fig.1 FORWARD CURRENT VS. FORWARD VOLTAGE

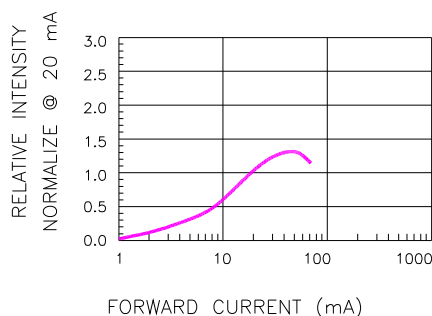

Fig.2 RELATIVE INTENSITY VS. FORWARD CURRENT

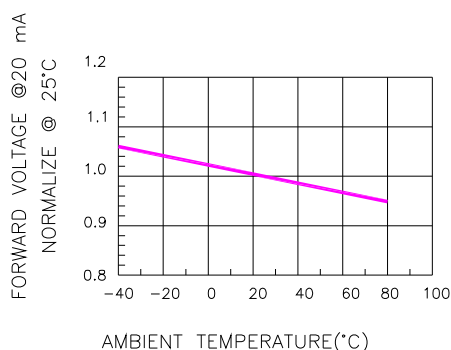

Fig.3 FORWARD VOLTAGE VS. TEMPERATURE

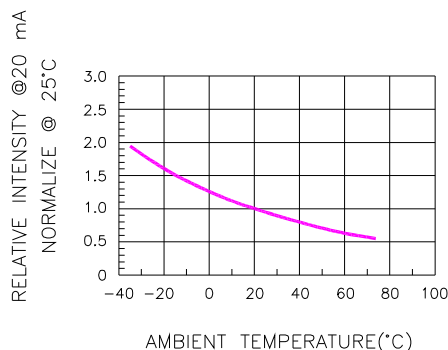

Fig.4 RELATIVE INTENSITY VS. TEMPERATURE

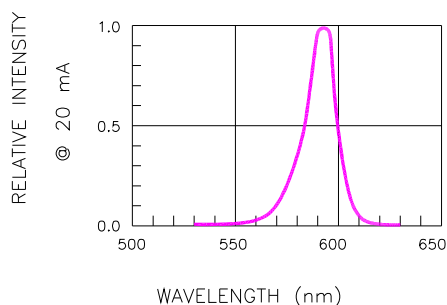

Fig.5 RELATIVE INTENSITY VS. WAVELENGTH

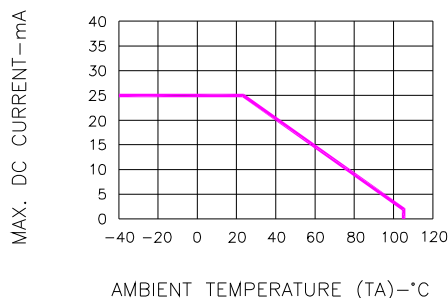

Fig.6 MAX. ALLOWABLE DC CURRENT VS. AMBIENT TEMPERATURE



**Opto Plus LED Corp.**  
**0.28" SMD Type LED Display**  
**OPS-Q2810LY-GW**  
**OPS-Q2811LY-GW**

● **RECOMMEND SOLDERING PROFILE**

SMT Soldering Profile

Pb free reflow soldering Profile

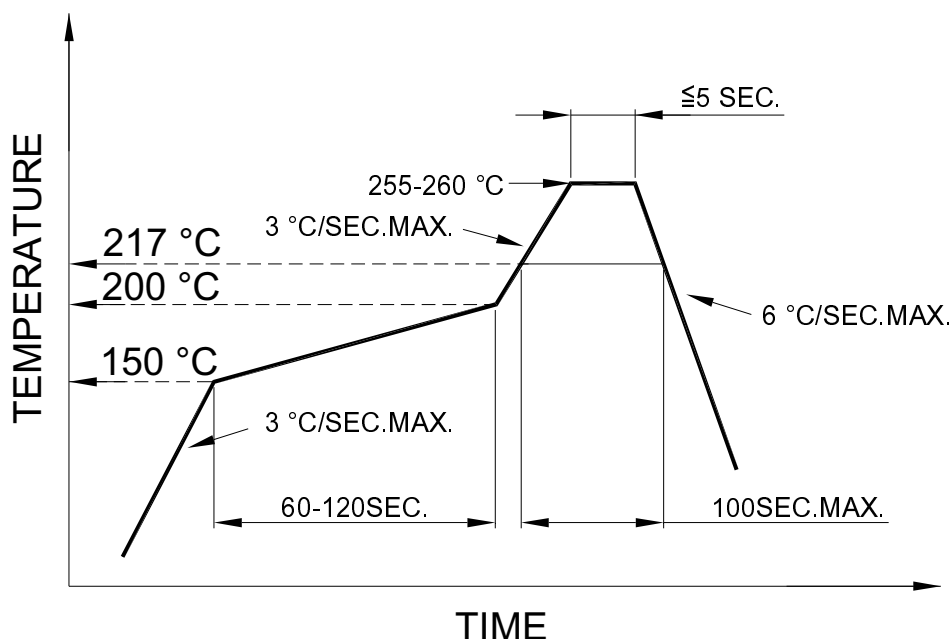

● **SOLDERING IRON**

Basic specification :  $\leq 4$  seconds when 260°C, If temperature is higher, time should be shorter (+10°C→1 sec). Power dissipation of iron should be smaller than 15W, and temperature should be controllable. Surface temperature of the device should be under 230°C.

● **REWORK**

Customer must finish rework within  $\leq 3$  sec under 350°C.