



Opto Plus LED Corp.
0.20" SMD Type LED Display
OPS-D2010PG-GW
OPS-D2011PG-GW

● **EDIT HISTORY**

Version A: Oct. 20, 2014

Preliminary Spec.

Manufacture	Examination	Approving



Opto Plus LED Corp.
0.20" SMD Type LED Display
OPS-D2010PG-GW
OPS-D2011PG-GW

● **FEATURES**

- 0.20 inch (5.08 mm) Digit Height.
- SMD type.
- Low current operation.
- Gray face, White segment.
- RoHS compliant, Pb Free.

● **DESCRIPTION**

The OPS-D2010PG-GW & OPS-D2011PG-GW are 0.20 inch (5.08 mm) height Dual digits 7-segment display.

This device utilizes Pure Green chip which are made from InGaN on a Tansparent GaN, substrate.

The display has Gray face, White segment.

● **DEVICE**

PART NO	DESCRIPTION
OPS-D2010PG-GW	Common Anode
OPS-D2011PG-GW	Common Cathode

RoHS Compliance



Pb free.



Version: A Date: 10/20/2014

Opto Plus LED Corp. 7F-3, No.496, Bannan Road, Zhonghe Dist., New Taipei City 235, Taiwan (R.O.C)

Website: www.opled.com.tw E-mail: sales@opled.com.tw Tel: 886-2-2222-5698 Fax: 886-2-2222-2566

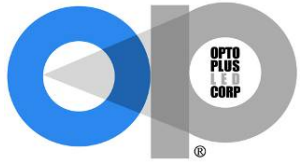

Opto Plus LED Corp.
0.20" SMD Type LED Display
OPS-D2010PG-GW
OPS-D2011PG-GW

● **MECHANICAL DIMENSIONS**

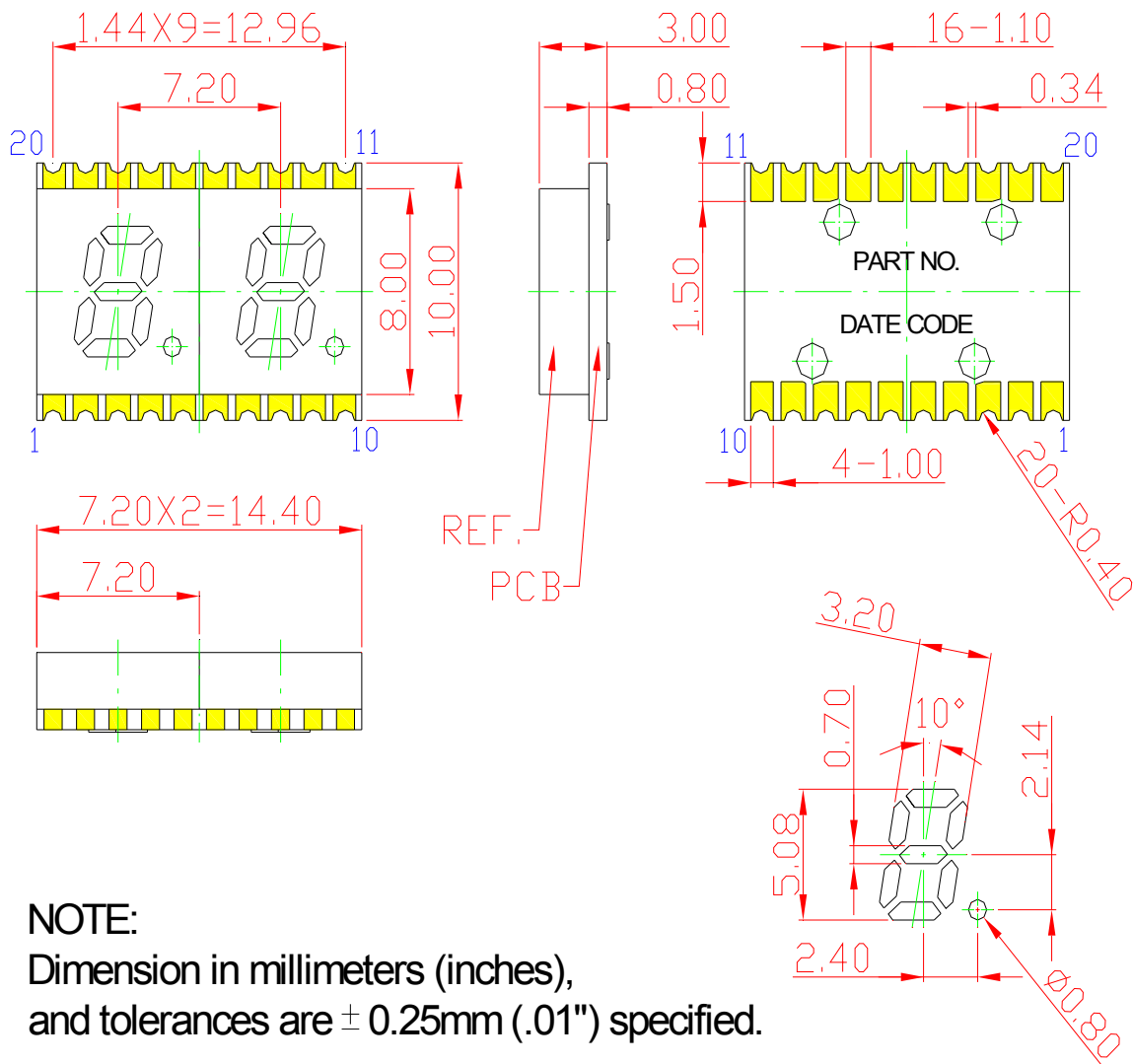

NOTE:
 Dimension in millimeters (inches),
 and tolerances are ± 0.25 mm (.01") specified.



Opto Plus LED Corp.

0.20" SMD Type LED Display

OPS-D2010PG-GW

OPS-D2011PG-GW

● TYPICAL INTERNAL EQUIVALENT CIRCUIT

Recommended Soldering Pattern

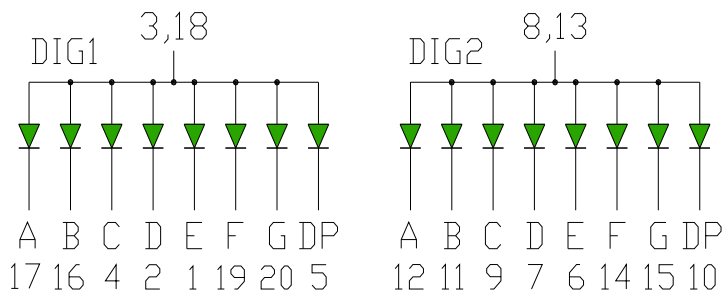
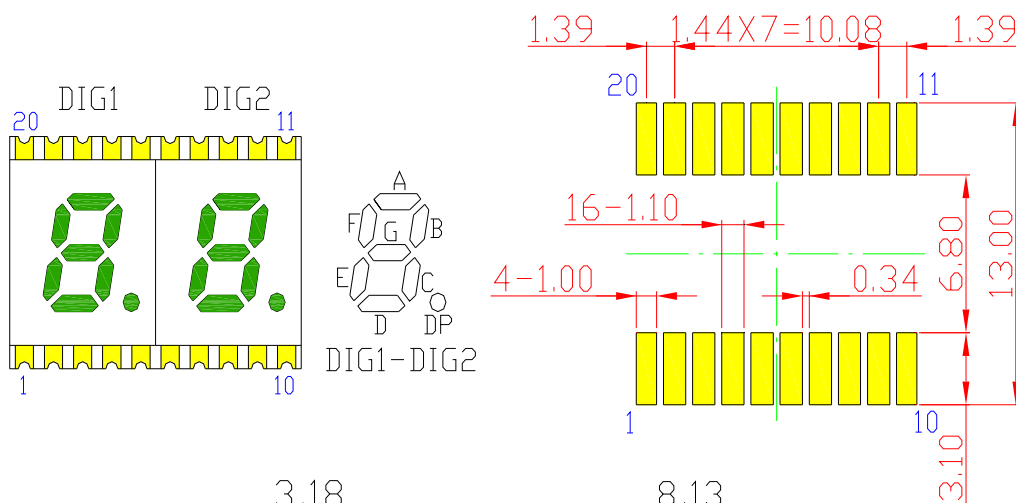



Opto Plus LED Corp.
0.20'' SMD Type LED Display
OPS-D2010PG-GW
OPS-D2011PG-GW

● **PG: PURE GREEN (InGaN/GaN)**

ABSOLUTE MAXIMUM RATING AT Ta=25°C

Parameter	Symbol	Maximum Rating	Unit
Power dissipation	P _{AD}	120	mW
Derating liner from 25°C	-	0.3	mA / °C
Continuous forward current	I _{AF}	30	mA
Peak current (duty cycle 1/10, 1kHz)	I _{PF}	100	mA
Reverse voltage	V _R	5	V
Operating temperature	T _{OPR}	-40 to +105	°C
Storage temperature	T _{STG}	-40 to +105	°C

ELECTRICAL - OPTICAL CHARACTERISTICS AT Ta=25°C

Characteristic	Symbol	Condition	Min.	Type.	Max.	Unit
Forward Voltage, (Per Dice)	V _F	I _F = 20mA	-	3.2	4.0	V
Reverse Current, (Per Dice)	I _R	V _R = 8V	-	-	10	μA
Dominant Wavelength	λ _D	I _F = 20mA	-	525	-	nm
Luminous Intensity	I _v	I _F = 20mA	-	50	-	mcd
Spectral radiation bandwidth	Δλ	I _F = 20mA	-	30	-	nm

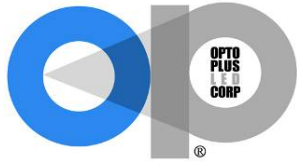

Opto Plus LED Corp.

0.20" SMD Type LED Display

OPS-D2010PG-GW

OPS-D2011PG-GW

● PG: PURE GREEN (InGaN/GaN) CURVE

Typical Electro-optical Characteristic Curves
(25 °C Free Air Temperature Unless Otherwise Specified)

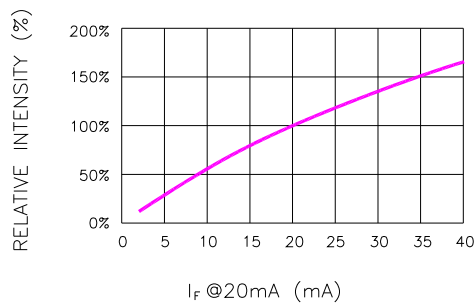

Fig.1 RELATIVE INTENSITY VS. FORWARD CURRENT

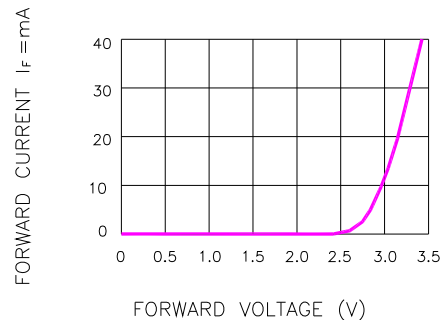

Fig.2 FORWARD CURRENT VS. FORWARD VOLTAGE

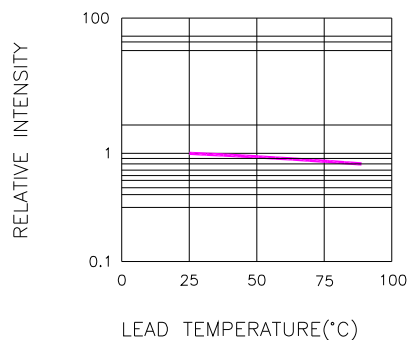

Fig.3 RELATIVE INTENSITY VS. LEAD TEMPERATURE
(PULSED 20 mA; 300us PULSE, 10ms PERIOD)

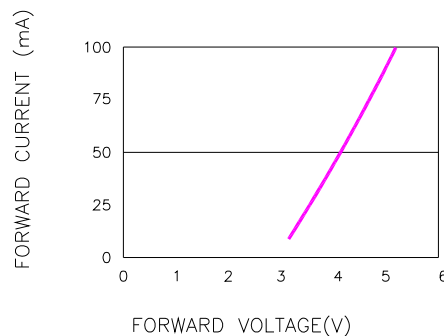

Fig.4 PEAK FORWARD VOLTAGE VS. FORWARD (100us TEST PULSE, 1% DUTY CYCLE)

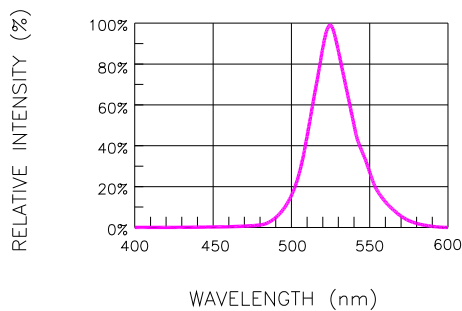

Fig.5 RELATIVE INTENSITY VS. WAVELENGTH

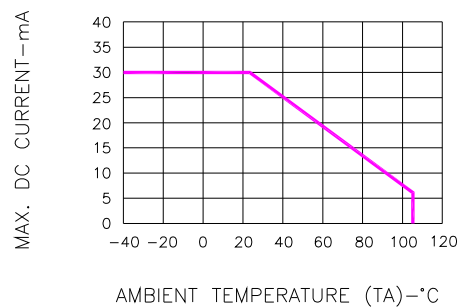

Fig.6 MAX. ALLOWABLE DC CURRENT VS. AMBIENT TEMPERATURE

Version: A Date: 10/20/2014

Opto Plus LED Corp. 7F-3, No.496, Bannan Road, Zhonghe Dist., New Taipei City 235, Taiwan (R.O.C)

Website: www.opled.com.tw E-mail: sales@opled.com.tw Tel: 886-2-2222-5698 Fax: 886-2-2222-2566



Opto Plus LED Corp.
0.20'' SMD Type LED Display
OPS-D2010PG-GW
OPS-D2011PG-GW

● **SMT REFLOW SOLDERING INSTRUCTIONS**

SMT Soldering Profile

Pb free reflow soldering Profile

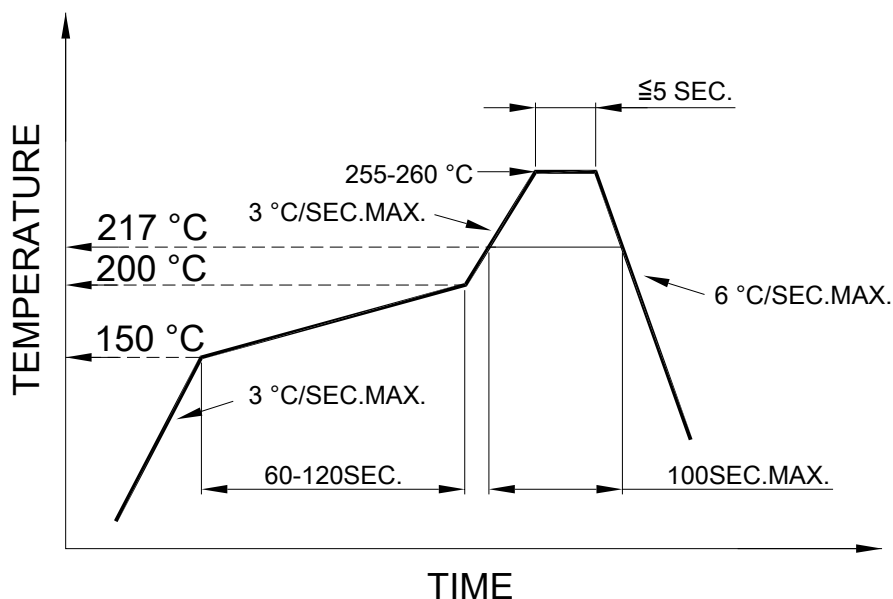

● **SOLDERING IRON**

Basic spec is ≤ 4 sec when 260°C. If temperature is higher, time should be shorter (+10°C→1 sec). Power dissipation of Iron should be smaller than 15W, and temperature should be controllable. Surface temperature of the device should be under 230°C.

● **REWORK**

- Customer must finish rework within 3 sec. under 350°C.
- The head of soldering iron cannot touch copper foil.

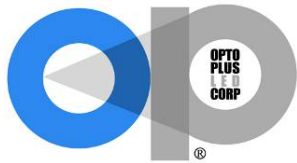

Opto Plus LED Corp.

0.20" SMD Type LED Display

OPS-D2010PG-GW

OPS-D2011PG-GW

● REEL DIMENSIONS

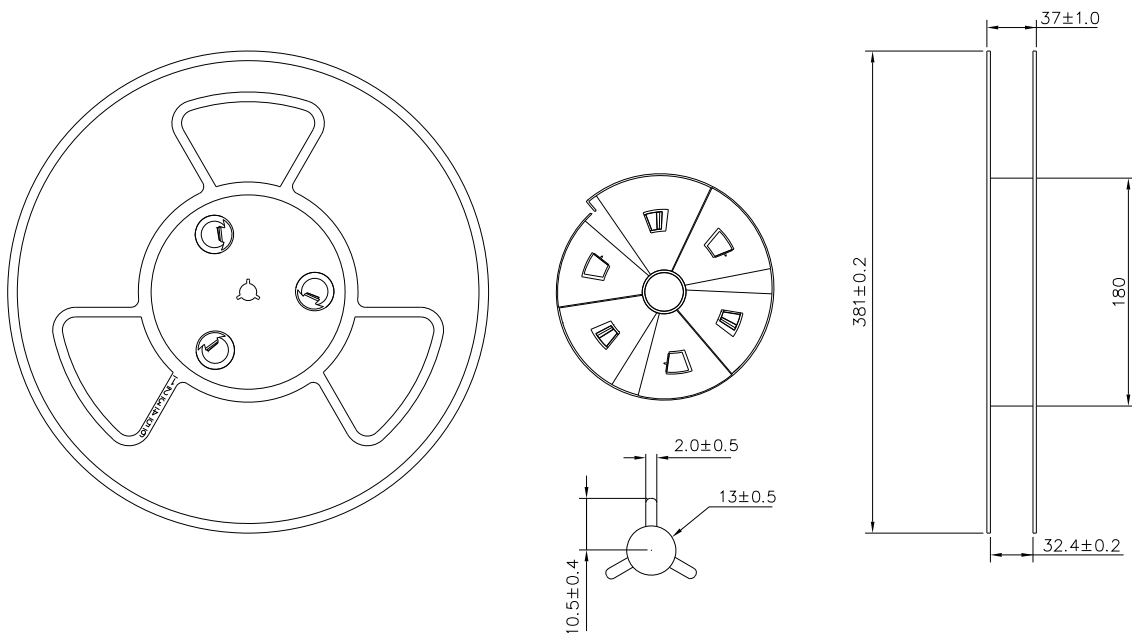

● PACKING & LABEL SPECIFICATIONS

