



www.opled.com.tw

Opto Plus LED Corp.
Case Mold Type LED Display
OPD-V1515PG-PD-BW

● **EDIT HISTORY**

Version A: Nov.18, 2017

Preliminary Spec.



Opto Plus LED Corp. Case Mold Type LED Display OPD-V1515PG-PD-BW

● FEATURES

- Excellent character appearance.
- Case mold type.
- Touch pad.
- Black face (overlay) / White segment.
- RoHS compliant, Pb Free.

● DESCRIPTION

The OPD-V1515PG-PD-BW is a Touch Pad with 15.0 mm X 15.0 mm icon LED display. This device utilizes Pure Green LED chip which are made from InGaN on a transparent GaN substrate. The display has Black face (overlay), White segment. This mold of display is attached with overlay.

● DEVICE

PART NO.	DESCRIPTION
OPD-V1515PG-PD-BW	Touch pad with LED Display

RoHS Compliance



Pb free.



MECHANICAL DIMENSIONS

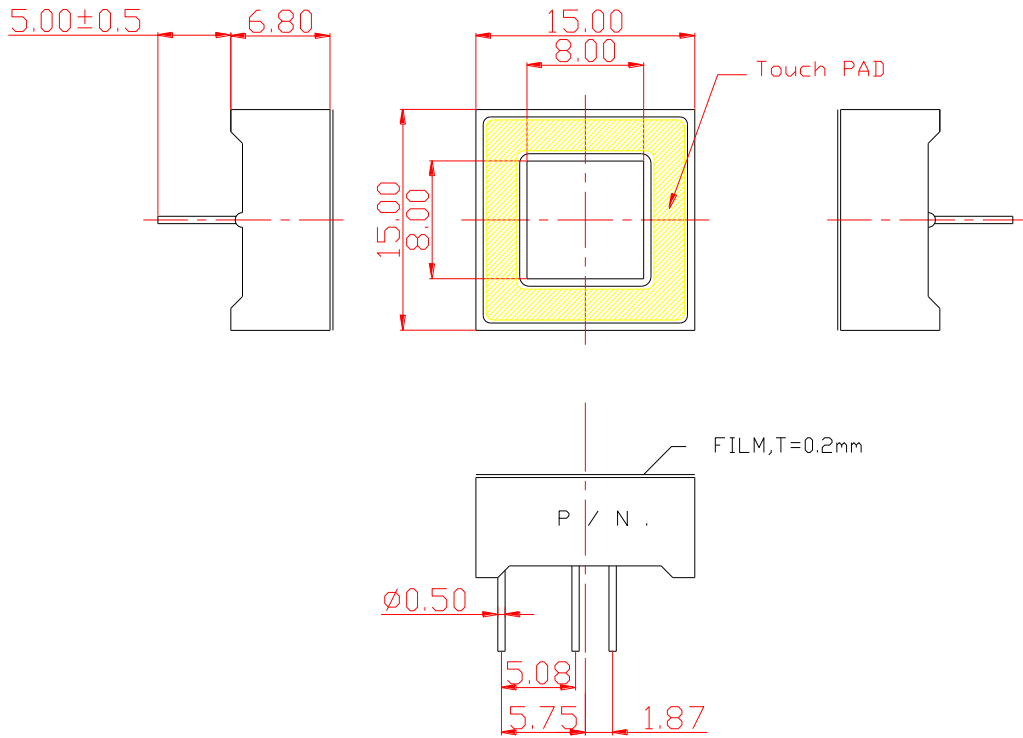

Dimension in millimeters (inches), and tolerances are $\pm 0.25\text{mm}$ (.01") specified.

TYPICAL INTERNAL EQUIVALENT CIRCUIT

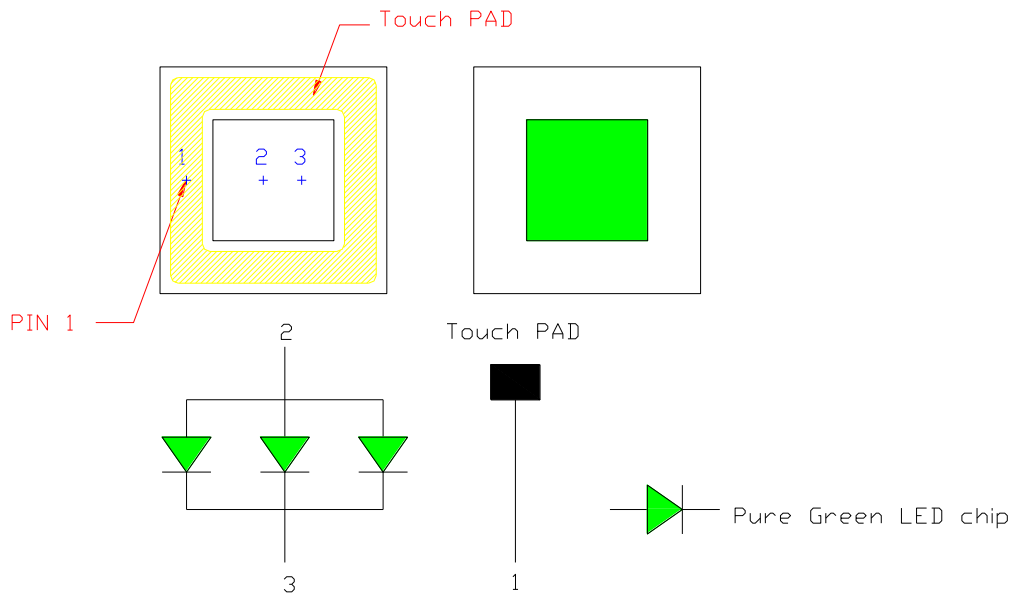

● Application Circuits

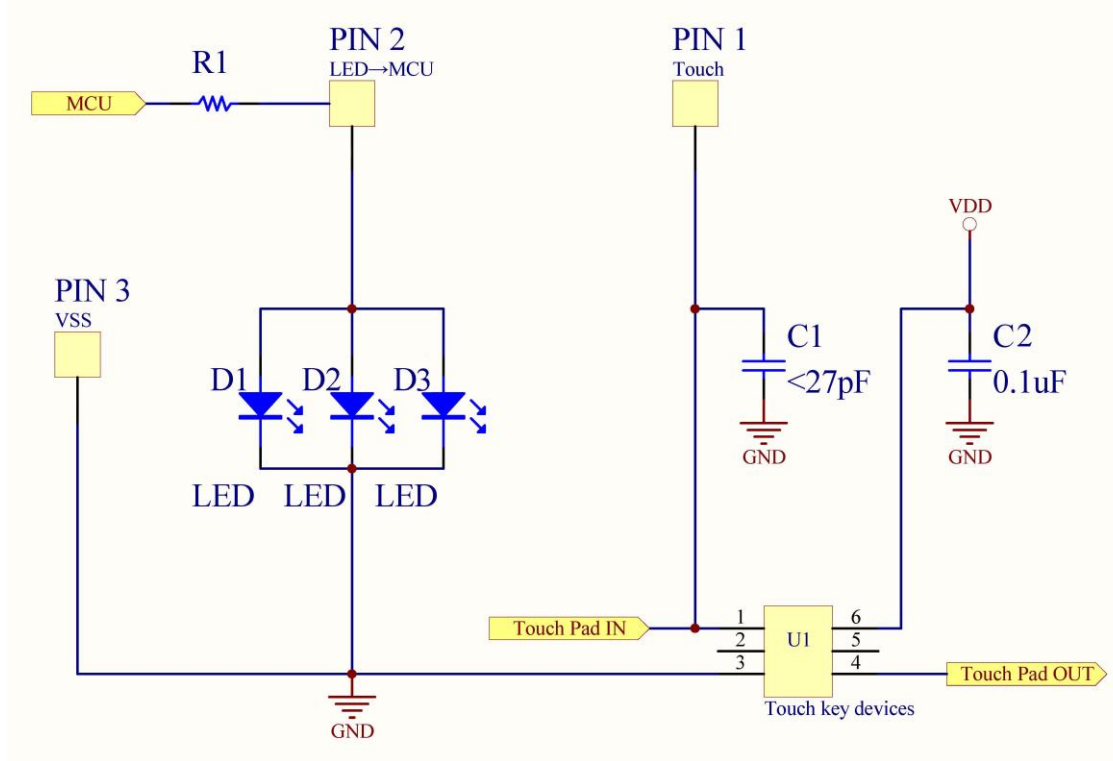

INTERNAL COMPONENTS , NOT CUSTOMER ACCESSINLE.

● FILM

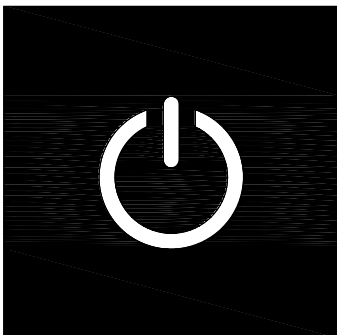



www.opled.com.tw

Opto Plus LED Corp. Case Mold Type LED Display OPD-V1515PG-PD-BW

● PG: PURE GREEN (InGaN/GaN)

ABSOLUTE MAXIMUM RATING AT Ta=25°C

Parameter	Symbol	Pure Green	Unit
Power dissipation per dice	P _{AD}	120	mW
Derating liner from 25°C per dice	-	0.3	mA / °C
Continuous forward current per dice	I _{AF}	30	mA
Peak current per dice (duty cycle 1/10, 1kHz)	I _{PF}	100	mA
Reverse voltage per dice	V _R	5	V
Operating temperature	T _{OPR}	-25 to +85	°C
Storage temperature	T _{STG}	-25 to +85	°C

ELECTRICAL - OPTICAL CHARACTERISTICS AT Ta=25°C

Characteristic	Symbol	Condition	Min.	Typ.	Max.	Unit
Forward voltage	V _F	I _F =20mA	-	3.2	4.0	V
Reverse current	I _R	V _R =8V	-	-	10	μA
Dominant wavelength	λ _D	I _F =20mA	-	525	-	nm
Luminous intensity	I _v	I _F =20mA	-	90	-	mcd
Spectral radiation bandwidth	Δλ	I _F =20mA	-	30	-	nm



Opto Plus LED Corp. Case Mold Type LED Display OPD-V1515PG-PD-BW

● PG: PURE GREEN (InGaN/GaN) CURVE

Typical Electro-optical Characteristic Curves (25 °C Free Air Temperature Unless Otherwise Specified)

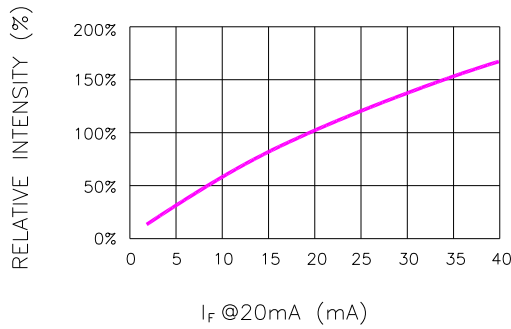

Fig.1 RELATIVE INTENSITY VS. FORWARD CURRENT

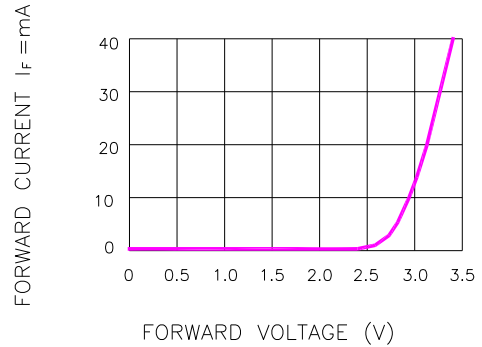

Fig.2 FORWARD CURRENT VS. FORWARD VOLTAGE

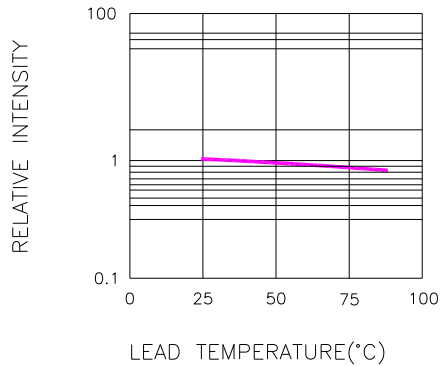

Fig.3 RELATIVE INTENSITY VS. LEAD TEMPERATURE
(PULSED 20 mA; 300us PULSE, 10ms PERIOD)

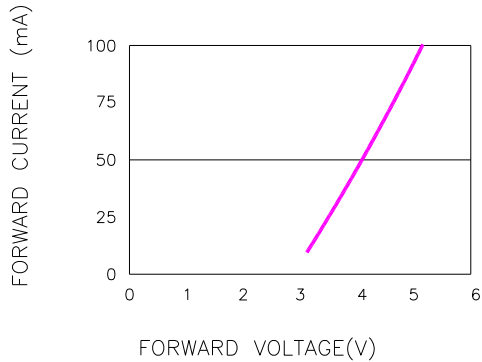

Fig.4 PEAK FORWARD VOLTAGE VS. FORWARD CURRENT
(100us TEST PULSE, 1% DUTY CYCLE)

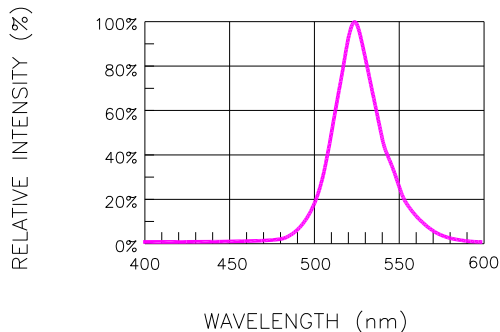

Fig.5 RELATIVE INTENSITY VS. WAVELENGTH

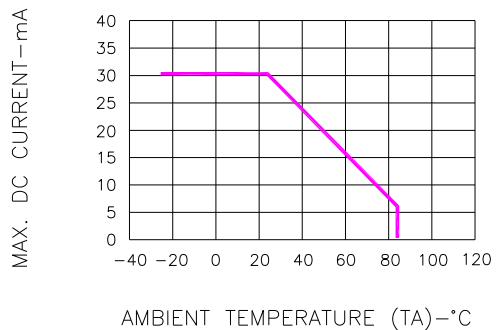
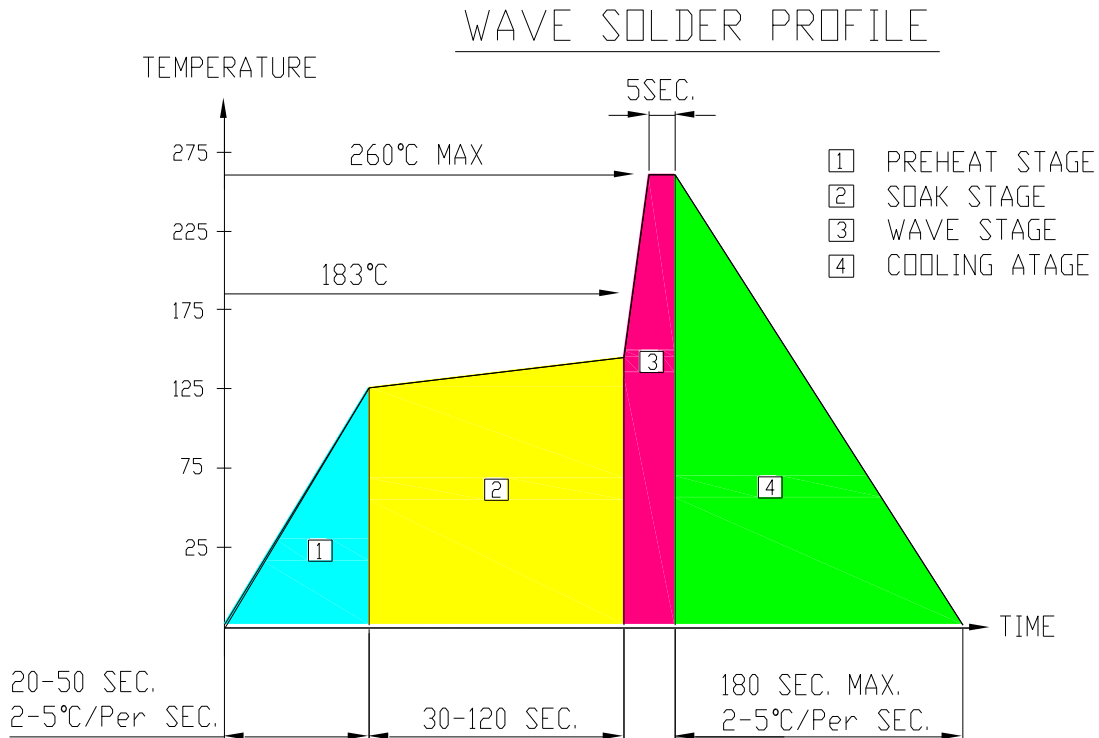

Fig.6 MAX. ALLOWABLE DC CURRENT VS. AMBIENT TEMPERATURE

● **RECOMMEND SOLDERING PROFILE**



● **Note:**

- Recommend pre-heat temperature of 105°C or less (as measured with a thermocouple attached to the LED pins) prior to immersion in the solder wave with a maximum solder bath temperature of 260°C
- Peak wave soldering temperature between 245°C ~ 225°C for 3 sec (5 sec max)
- No more than one wave soldering pass

● **SOLDERING IRON**

Basic spec is ≤ 4 sec when 260°C. If temperature is higher, time should be shorter (+10°C → 1 sec). Power dissipation of Iron should be smaller than 15W, and temperature should be controllable. Surface temperature of the device should be under 230°C.

● **REWORK**

Customer must finish rework within ≤ 3 sec under 350°C.
 The head of soldering iron cannot touch copper foil.