



www.opled.com.tw

Opto Plus LED Corp.
Case Mold Type LED Display
OPD-V1515LY-PD-BW

● **EDIT HISTORY**

Version A: Nov.18, 2017

Preliminary Spec.



www.opled.com.tw

Opto Plus LED Corp. Case Mold Type LED Display OPD-V1515LY-PD-BW

● FEATURES

- Excellent character appearance.
- Case mold type.
- Touch pad.
- Black face (overlay) / White segment.
- RoHS compliant, Pb Free.

● DESCRIPTION

The OPD-V1515LY-PD-BW is a Touch Pad with 15.0 mm X 15.0 mm icon LED display. This device utilizes Super Bright Yellow LED chip which are made from AlGaInP on a transparent GaAs substrate.

The display has Black face (overlay), White segment.

This mold of display is attached with overlay.

● DEVICE

PART NO.	DESCRIPTION
OPD-V1515LY-PD-BW	Touch pad with LED Display

RoHS Compliance



Pb free.



● MECHANICAL DIMENSIONS

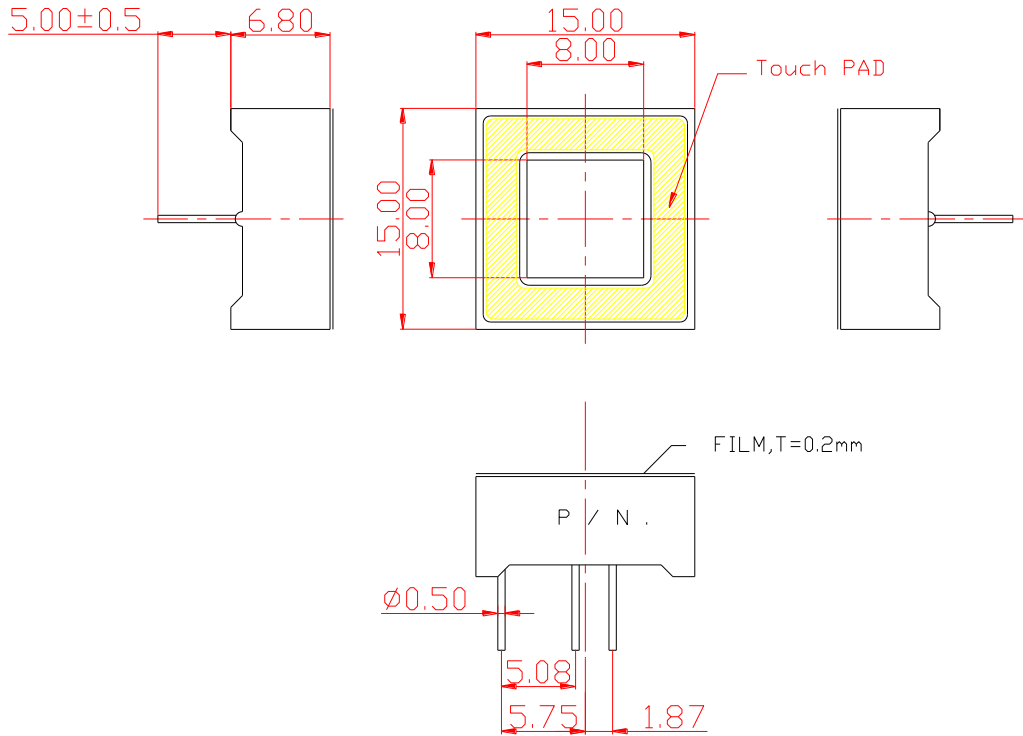

Dimension in millimeters (inches), and tolerances are ±0.25mm (.01") specified.

● TYPICAL INTERNAL EQUIVALENT CIRCUIT

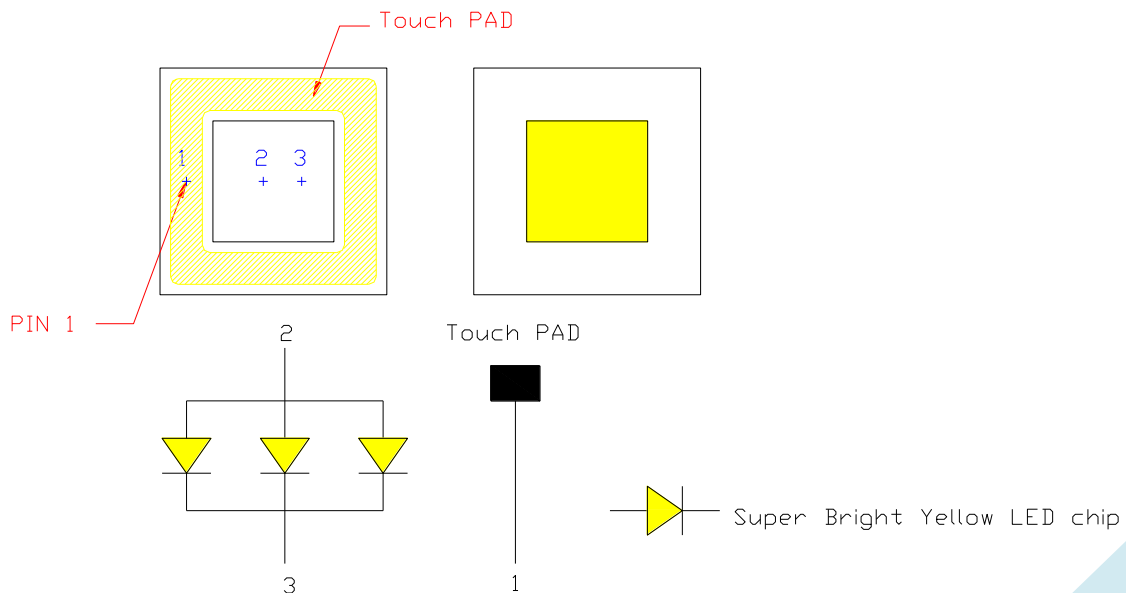

● Application Circuits

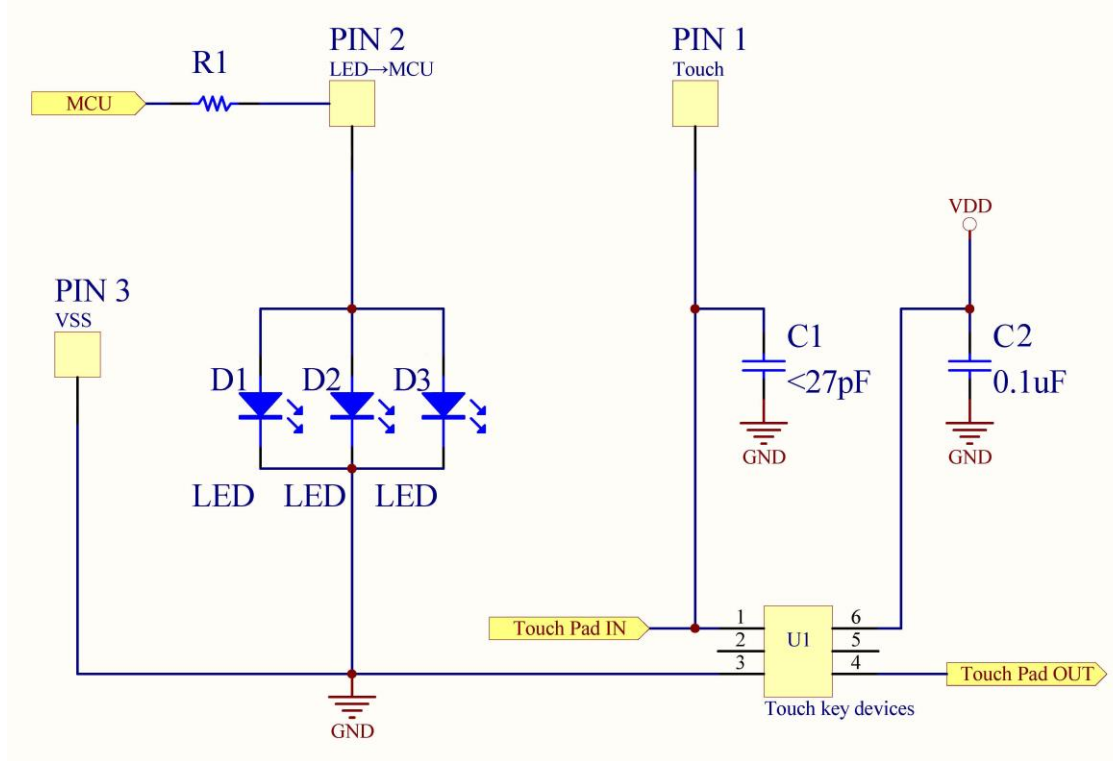

INTERNAL COMPONENTS , NOT CUSTOMER ACCESSINLE.

● FILM

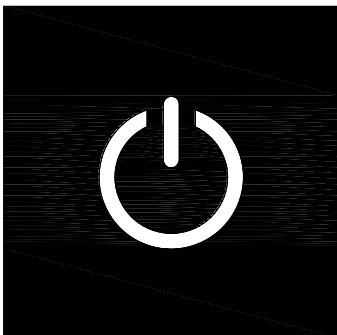



www.opled.com.tw

Opto Plus LED Corp. Case Mold Type LED Display OPD-V1515LY-PD-BW

● LY: SUPER BRIGHT YELLOW (AlGaInP/GaAs)

ABSOLUTE MAXIMUM RATING AT Ta=25°C

Parameter	Symbol	Super Bright Yellow	Unit
Power dissipation per dice	P _{AD}	70	mW
Derating liner from 25°C per dice	-	0.28	mA / °C
Continuous forward current per dice	I _{AF}	25	mA
Peak current per dice (duty cycle 1/10, 1kHz)	I _{PF}	90	mA
Reverse voltage per dice	V _R	5	V
Operating temperature	T _{OPR}	-25 to +85	°C
Storage temperature	T _{STG}	-25 to +85	°C

ELECTRICAL - OPTICAL CHARACTERISTICS AT Ta=25°C

Characteristic	Symbol	Condition	Min.	Typ.	Max.	Unit
Forward Voltage	V _F	I _F =20mA	-	2.1	2.6	V
Reverse Current	I _R	V _R =5V	-	-	10	μA
Peak Wavelength	λ _P	I _F =20mA	-	593	-	nm
Dominant Wavelength	λ _D	I _F =20mA	-	590	-	nm
Average Luminous Intensity	I _v	I _F =20mA	-	50	-	mcd
Spectrum Radiation Bandwidth	Δλ	I _F =20mA	-	20	-	nm



Opto Plus LED Corp. Case Mold Type LED Display OPD-V1515LY-PD-BW

● LY: SUPER BRIGHT YELLOW (AlGaInP/GaAs) CURVE

Typical Electro-optical Characteristic Curves
(25°C Free Air Temperature Unless Otherwise Specified)

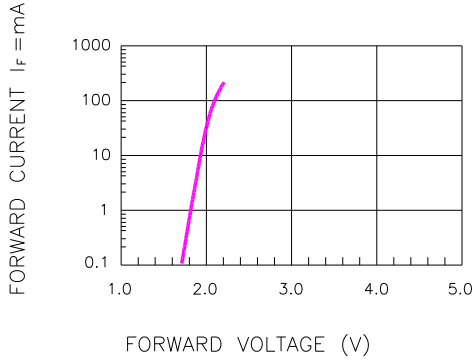

Fig.1 FORWARD CURRENT VS. FORWARD VOLTAGE

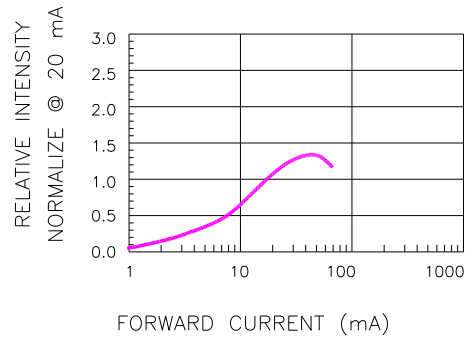

Fig.2 RELATIVE INTENSITY VS. FORWARD CURRENT

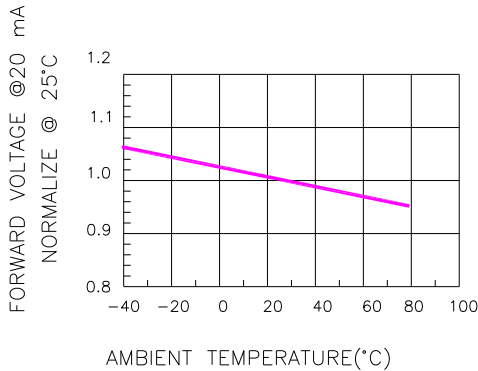

Fig.3 FORWARD VOLTAGE VS. TEMPERATURE

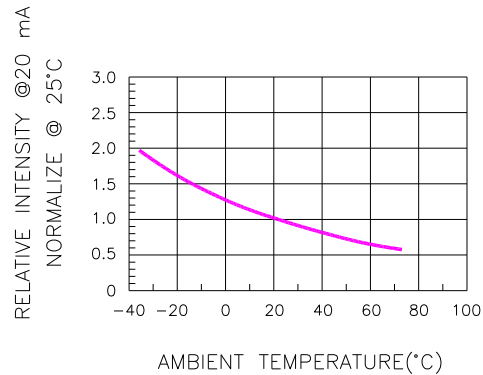

Fig.4 RELATIVE INTENSITY VS. TEMPERATURE

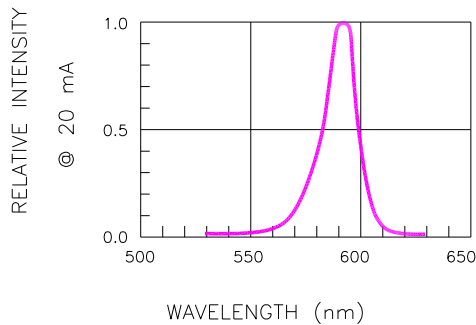

Fig.5 RELATIVE INTENSITY VS. WAVELENGTH

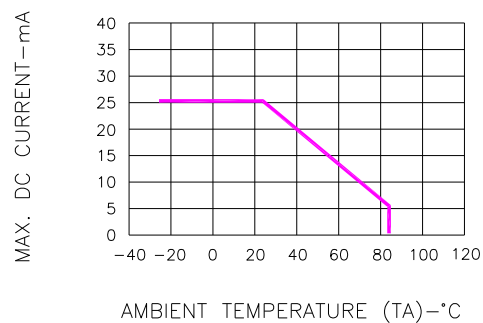
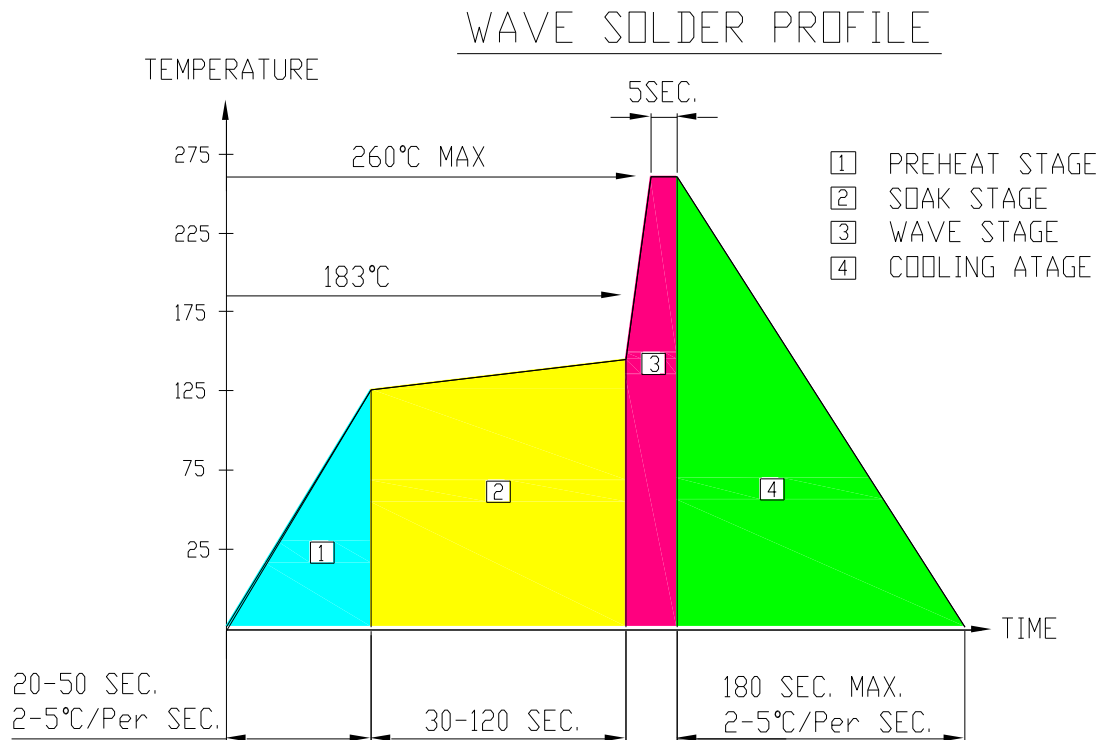

Fig.6 MAX. ALLOWABLE DC CURRENT VS. AMBIENT TEMPERATURE

● **RECOMMEND SOLDERING PROFILE**



● **Note:**

- Recommend pre-heat temperature of 105°C or less (as measured with a thermocouple attached to the LED pins) prior to immersion in the solder wave with a maximum solder bath temperature of 260°C
- Peak wave soldering temperature between 245°C ~ 225°C for 3 sec (5 sec max)
- No more than one wave soldering pass

● **SOLDERING IRON**

Basic spec is ≤ 4 sec when 260°C. If temperature is higher, time should be shorter (+10°C → 1 sec). Power dissipation of Iron should be smaller than 15W, and temperature should be controllable. Surface temperature of the device should be under 230°C.

● **REWORK**

Customer must finish rework within ≤ 3 sec under 350°C.
 The head of soldering iron cannot touch copper foil.