

Opto Plus LED Corp.
0.4" Case Mold Type LED Display
OPD-T4010UPG-BW
OPD-T4011UPG-BW

● **FEATURES**

- 0.4 inch (10.2 mm) Digit Height.
- Low current operation.
- Case mold type.
- Black face, White segment.
- RoHS compliant, Pb Free.

● **DESCRIPTION**

The OPD-T4010UPG-BW & OPD-T4011UPG-BW is a 0.4 inch (10.2 mm) height triple digits display.

This device utilizes Pure Green LED chip which are made from InGaN on a transparent GaN. The display has Black face, White segment.

● **DEVICE**

PART NO Pure Green	DESCRIPTION
OPD-T4010UPG-BW	Common Anode
OPD-T4011UPG-BW	Common Cathode

RoHS Compliance



Pb free.



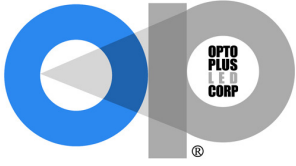

Opto Plus LED Corp.

0.4" Case Mold Type LED Display

OPD-T4010UPG-BW

OPD-T4011UPG-BW

MECHANICAL DIMENSIONS

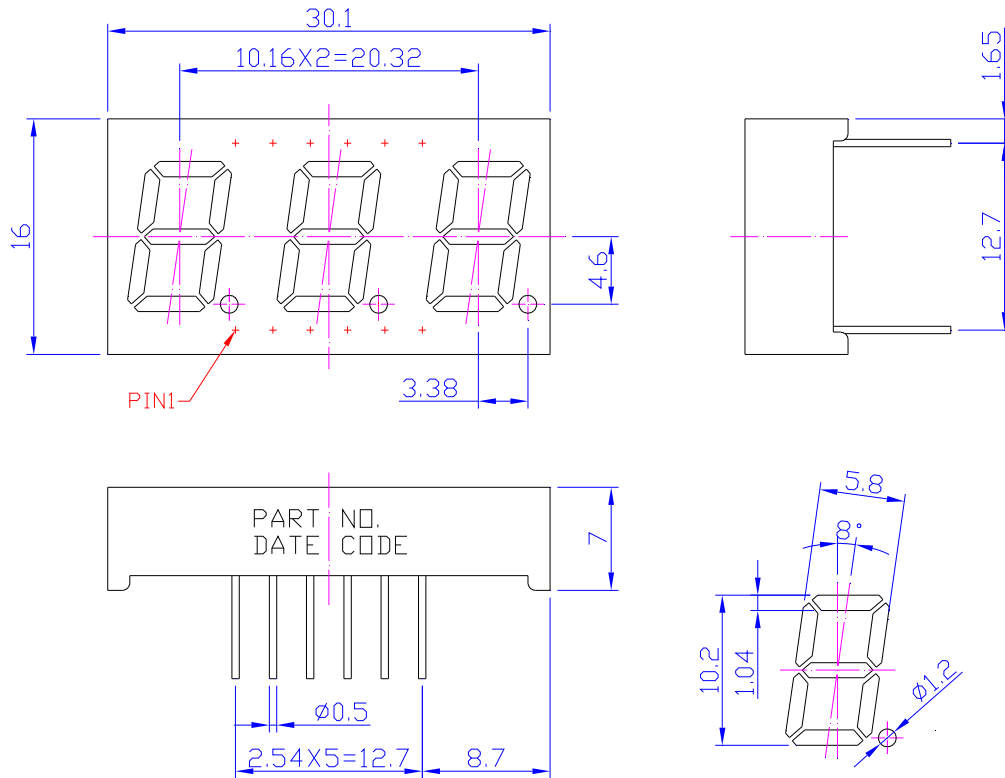

NOTES: All dimensions are in millimeters. Tolerances are ± 0.25 mm unless otherwise noted.

TYPICAL INTERNAL EQUIVALENT CIRCUIT

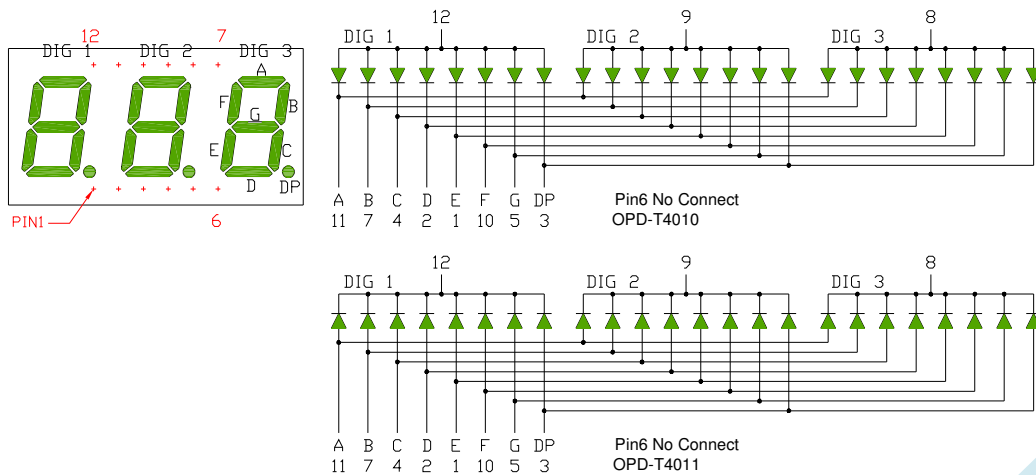

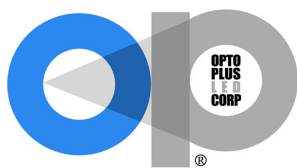

Opto Plus LED Corp.
0.4" Case Mold Type LED Display
OPD-T4010UPG-BW
OPD-T4011UPG-BW

● **PG: PURE GREEN (InGaN/GaN)**

ABSOLUTE MAXIMUM RATING AT Ta=25°C

Parameter	Symbol	Pure Green	Unit
Power dissipation per dice	P _{AD}	120	mW
Derating liner from 25°C per dice	-	0.3	mA / °C
Continuous forward current per dice	I _{AF}	30	mA
Peak current per dice (duty cycle 1/10, 1kHz)	I _{PF}	100	mA
Reverse voltage per dice	V _R	5	V
Operating temperature	T _{OPR}	-25 to +85	°C
Storage temperature	T _{STG}	-25 to +85	°C

ELECTRICAL - OPTICAL CHARACTERISTICS AT Ta=25°C

Characteristic	Symbol	Condition	Min.	Typ.	Max.	Unit
Forward voltage	V _F	I _F = 20mA	-	3.2	4.0	V
Reverse current	I _R	V _R = 8V	-	-	10	μA
Dominant wavelength	λ _D	I _F = 20mA	-	525	-	nm
Luminous intensity	I _v	I _F = 20mA	-	140	-	mcd
Spectral radiation bandwidth	Δλ	I _F = 20mA	-	30	-	nm

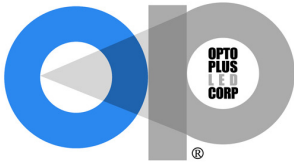

Opto Plus LED Corp.

0.4" Case Mold Type LED Display

OPD-T4010UPG-BW

OPD-T4011UPG-BW

● PG: PURE GREEN (InGaN/GaN) CURVE

Typical Electro-optical Characteristic Curves
(25 °C Free Air Temperature Unless Otherwise Specified)

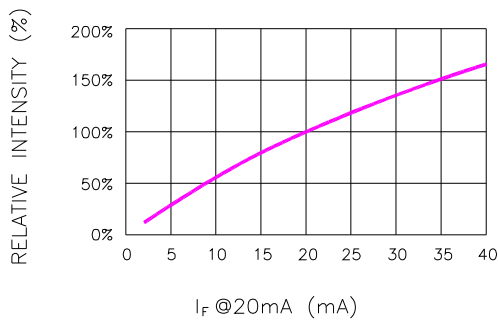

Fig.1 RELATIVE INTENSITY VS. FORWARD CURRENT

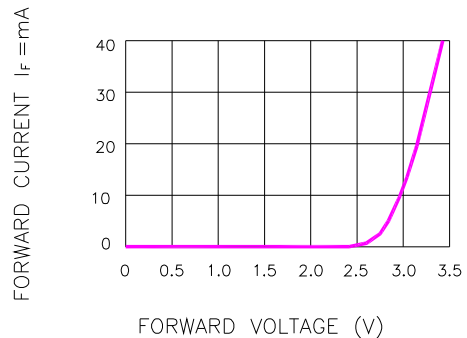

Fig.2 FORWARD CURRENT VS. FORWARD VOLTAGE

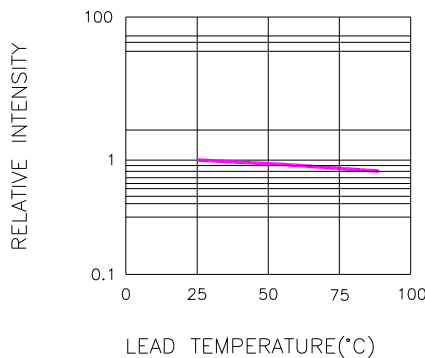

Fig.3 RELATIVE INTENSITY VS. LEAD TEMPERATURE
(PULSED 20 mA; 300us PULSE, 10ms PERIOD)

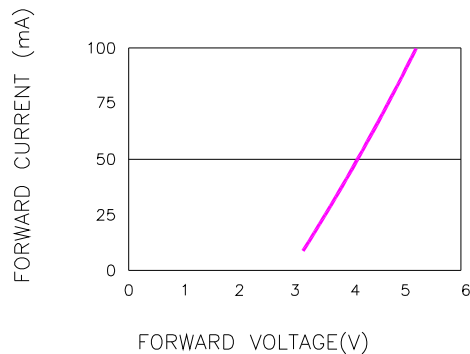

Fig.4 PEAK FORWARD VOLTAGE VS. FORWARD (100us TEST PULSE, 1% DUTY CYCLE)

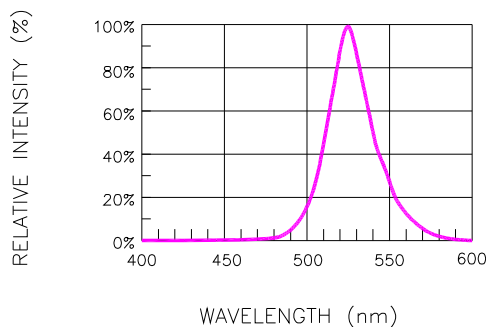

Fig.5 RELATIVE INTENSITY VS. WAVELENGTH

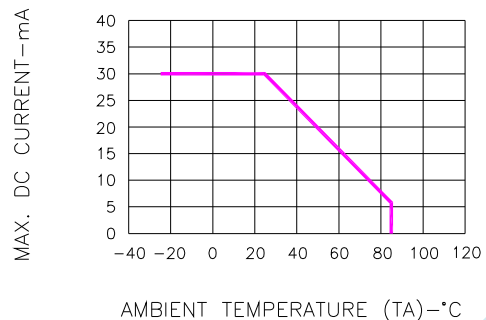
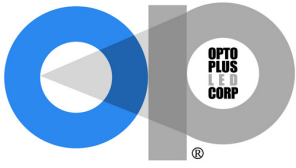
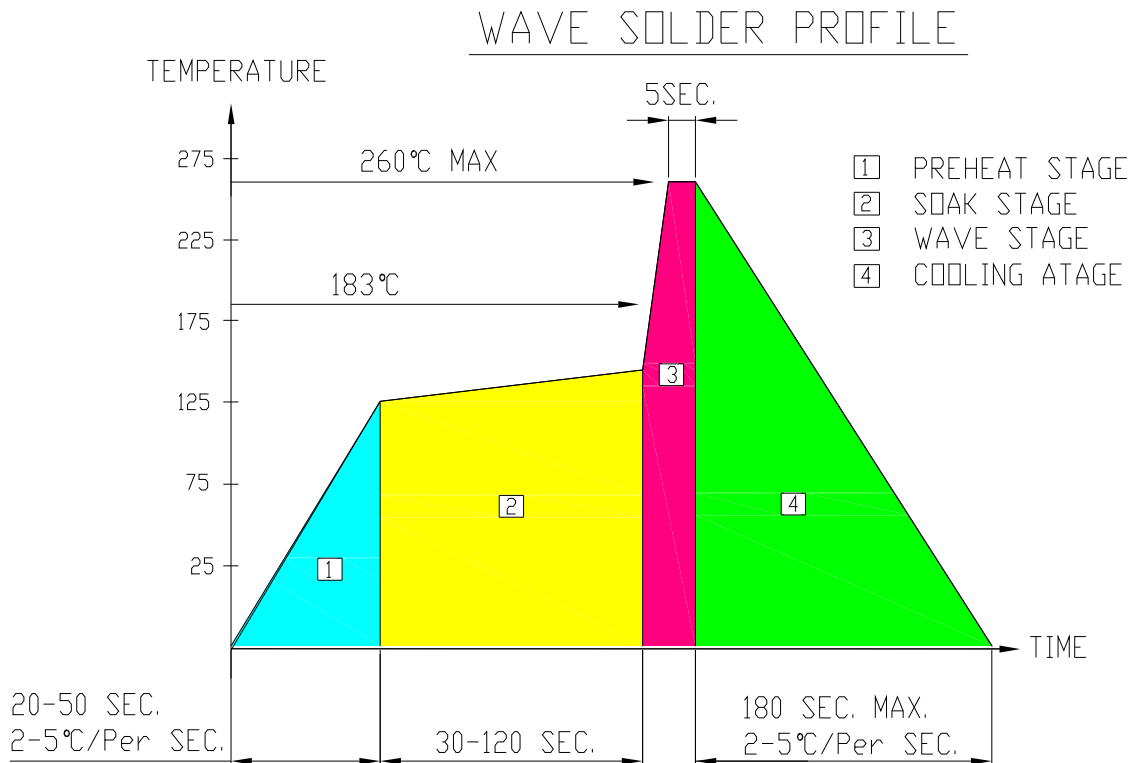

Fig.6 MAX. ALLOWABLE DC CURRENT VS. AMBIENT TEMPERATURE



Opto Plus LED Corp.
0.4" Case Mold Type LED Display
OPD-T4010UPG-BW
OPD-T4011UPG-BW

● **RECOMMEND SOLDERING PROFILE**



● **SOLDERING IRON**

Basic spec is ≤ 4 sec when 260°C. If temperature is higher, time should be shorter (+10°C→1 sec). Power dissipation of Iron should be smaller than 15W, and temperature should be controllable. Surface temperature of the device should be under 230°C.

● **REWORK**

Customer must finish rework within ≤ 4 sec under 245°C.