



Opto Plus LED Corp.
0.4" Case Mold Type LED Display
OPD-S4030LY-BW
OPD-S4031LY-BW

● **FEATURES**

- 0.4 inch (10.16 mm) Digit Height.
- Low current operation.
- Case mold type.
- Black face, White segment.
- RoHS compliant, Pb Free.

● **DESCRIPTION**

The OPD-S4030LY-BW & OPD-S4031LY-BW are a 0.4 inch (10.16 mm) height single 7-segment display.

This device utilizes Super Bright Yellow LED chip which are made from AlGaInP on a transparent GaAs substrate.

The display has Black face, White segment.

● **DEVICE**

PART NO	DESCRIPTION
Super Bright Yellow	
OPD-S4030LY-BW	Common Anode
OPD-S4031LY-BW	Common Cathode

RoHS Compliance



Pb free.





Opto Plus LED Corp.

0.4" Case Mold Type LED Display

OPD-S4030LY-BW

OPD-S4031LY-BW

● MECHANICAL DIMENSIONS

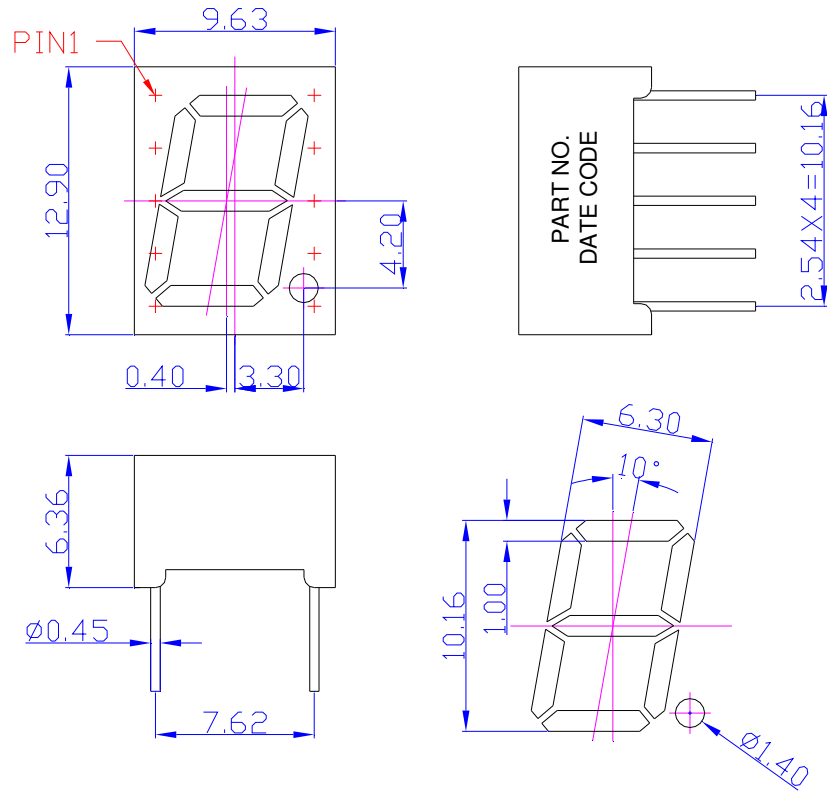

NOTES: Dimension is in millimeters. Tolerance is ± 0.25 mm unless otherwise noted.

● TYPICAL INTERNAL EQUIVALENT CIRCUIT

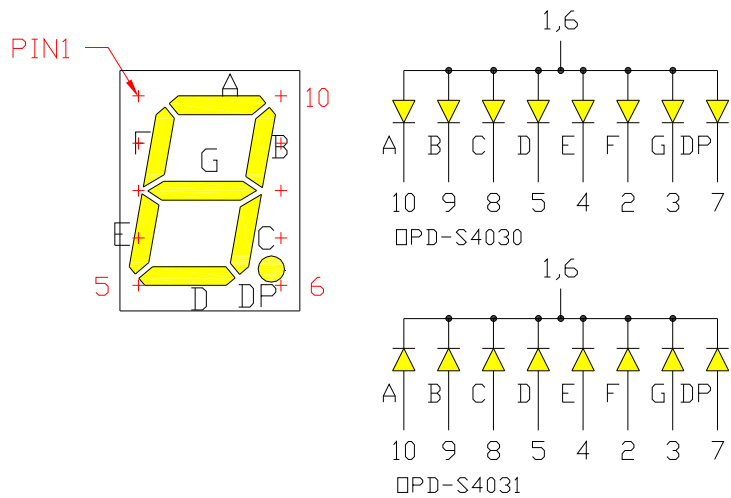



Opto Plus LED Corp.
0.4" Case Mold Type LED Display
OPD-S4030LY-BW
OPD-S4031LY-BW

● **LY: SUPER BRIGHT YELLOW (AlGaInP/GaAs)**

ABSOLUTE MAXIMUM RATING AT Ta=25°C

Parameter	Symbol	Super Bright Yellow	Unit
Power dissipation per dice	P _{AD}	70	mW
Derating liner from 25 °C per dice	-	0.28	mA / °C
Continuous forward current per dice	I _{AF}	25	mA
Peak current per dice (duty cycle 1/10, 1kHz)	I _{PF}	90	mA
Reverse voltage per dice	V _R	5	V
Operating temperature	T _{OPR}	-25 to +85	°C
Storage temperature	T _{STG}	-25 to +85	°C

ELECTRICAL - OPTICAL CHARACTERISTICS AT Ta=25°C

Characteristic	Symbol	Condition	Min.	Typ.	Max.	Unit
Forward voltage	V _F	I _F =20mA	-	2.0	2.6	V
Reverse current	I _R	V _R =5V	-	-	10	μA
Peak wavelength	λ _P	I _F =20mA	-	593	-	nm
Dominant wavelength	λ _D	I _F =20mA	-	590	-	nm
Luminous intensity	I _V	I _F =20mA	-	40	-	mcd
Spectral radiation bandwidth	Δλ	I _F =20mA	-	20	-	nm



Opto Plus LED Corp.

0.4" Case Mold Type LED Display

OPD-S4030LY-BW

OPD-S4031LY-BW

● LY: SUPER BRIGHT YELLOW (AlGaInP/GaAs) CURVE

Typical Electro-optical Characteristic Curves
(25 °C Free Air Temperature Unless Otherwise Specified)

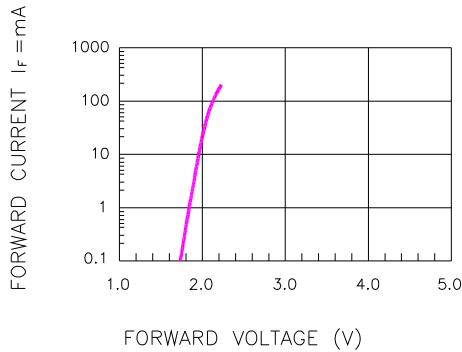

Fig.1 FORWARD CURRENT VS. FORWARD VOLTAGE

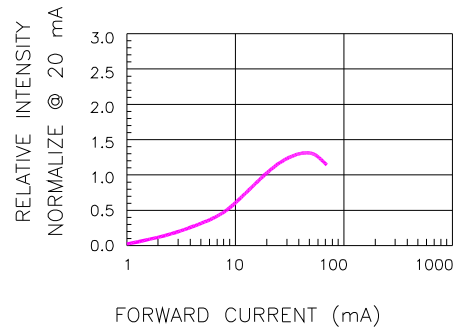

Fig.2 RELATIVE INTENSITY VS. FORWARD CURRENT

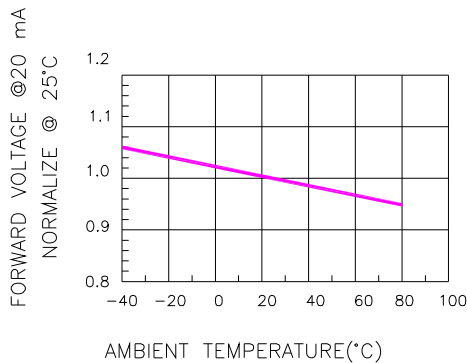

Fig.3 FORWARD VOLTAGE VS. TEMPERATURE

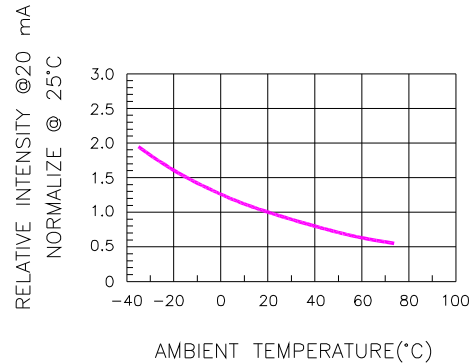

Fig.4 RELATIVE INTENSITY VS. TEMPERATURE

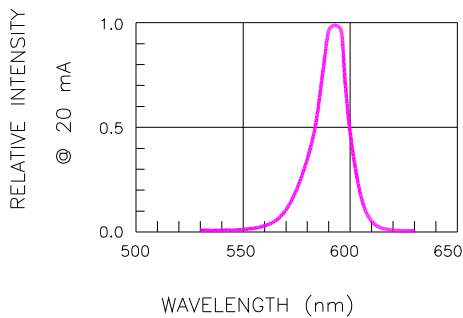

Fig.5 RELATIVE INTENSITY VS. WAVELENGTH

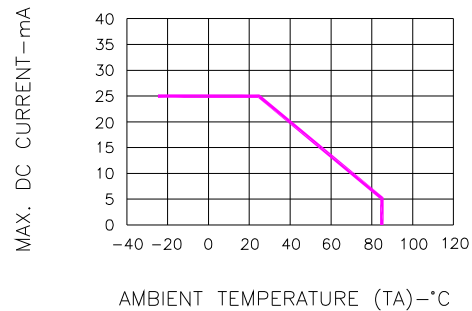

Fig.6 MAX. ALLOWABLE DC CURRENT VS. AMBIENT TEMPERATURE



Opto Plus LED Corp.
0.4" Case Mold Type LED Display
OPD-S4030LY-BW
OPD-S4031LY-BW

● **RECOMMEND SOLDERING PROFILE**



● **SOLDERING IRON**

Basic spec is ≤ 4 sec when 260°C. If temperature is higher, time should be shorter (+10°C→1 sec). Power dissipation of Iron should be smaller than 15W, and temperature should be controllable. Surface temperature of the device should be under 230°C.

● **REWORK**

Customer must finish rework within ≤ 4 sec under 245°C.