



Opto Plus LED Corp.
1.0" Case Mold Type LED Display
OPD-S10010LR-BW
OPD-S10011LR-BW

● **FEATURES**

- 1.0 inch (25.4 mm) Digit Height.
- Low current operation.
- Case mold type.
- Black face, White segment.
- RoHS compliant, Pb Free.

● **DESCRIPTION**

The OPD-S10010LR-BW & OPD-S10011LR-BW is a 1.0 inch (25.4 mm) height single 7-segment display.

This device utilizes Super Red LED chip which are made from AlGaInP on a transparent GaAs substrate. The display has Black face, White segment.

● **DEVICE**

PART NO Super Red	DESCRIPTION
OPD-S10010LR-BW	Common Anode
OPD-S10011LR-BW	Common Cathode

RoHS Compliance



Pb free.





Opto Plus LED Corp.

1.0" Case Mold Type LED Display

OPD-S10010LR-BW

OPD-S10011LR-BW

MECHANICAL DIMENSIONS

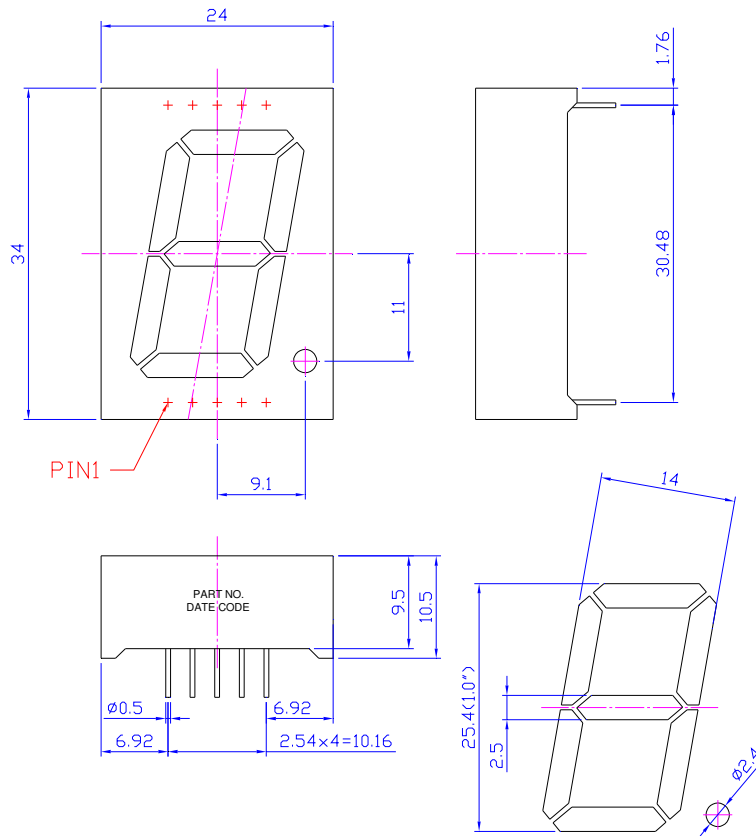

NOTES: All dimensions are in millimeters. Tolerances are ± 0.25 mm unless otherwise noted.

TYPICAL INTERNAL EQUIVALENT CIRCUIT

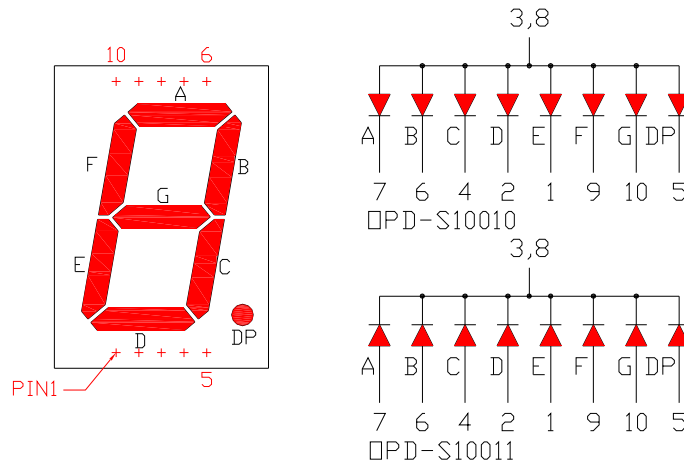



Opto Plus LED Corp.
1.0" Case Mold Type LED Display
OPD-S10010LR-BW
OPD-S10011LR-BW

● **LR: SUPER RED (AlGaInP/GaAs)**

ABSOLUTE MAXIMUM RATING AT $T_a=25^{\circ}\text{C}$

Parameter	Symbol	Super Red	Unit
Power dissipation per dice	P_{AD}	70	mW
Derating liner from 25 °C per dice	-	0.33	mA / °C
Continuous forward current per dice	I_{AF}	25	mA
Peak current per dice (duty cycle 1/10, 1kHz)	I_{PF}	90	mA
Reverse voltage per dice	V_R	5	V
Operating temperature	T_{OPR}	-25 to +85	°C
Storage temperature	T_{STG}	-25 to +85	°C

ELECTRICAL - OPTICAL CHARACTERISTICS AT $T_a=25^{\circ}\text{C}$

Characteristic	Symbol	Condition	Min.	Typ.	Max.	Unit
Forward voltage	V_F	$I_F = 20\text{mA}$	-	2.0	2.6	V
Reverse current	I_R	$V_R = 5\text{V}$	-	-	10	μA
Peak wavelength	λ_P	$I_F = 20\text{mA}$	-	650	-	nm
Dominant wavelength	λ_D	$I_F = 20\text{mA}$	-	639	-	nm
Luminous intensity	I_V	$I_F = 20\text{mA}$	-	40	-	mcd
Spectral radiation bandwidth	$\Delta\lambda$	$I_F = 20\text{mA}$	-	20	-	nm

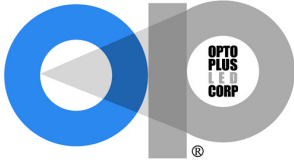

Opto Plus LED Corp.

1.0" Case Mold Type LED Display

OPD-S10010LR-BW

OPD-S10011LR-BW

● LR: SUPER RED (AlGaInP/GaAs)

Typical Electro-optical Characteristic Curves
(25 °C Free Air Temperature Unless Otherwise Specified)

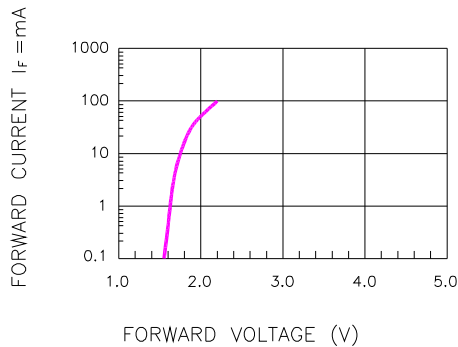

Fig.1 FORWARD CURRENT VS. FORWARD VOLTAGE

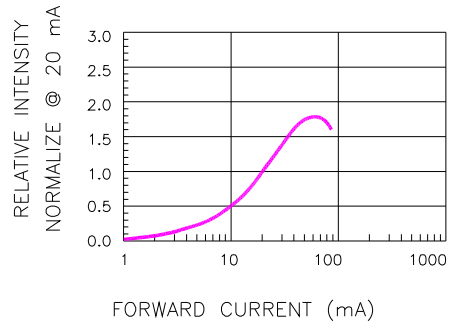

Fig.2 RELATIVE INTENSITY VS. FORWARD CURRENT

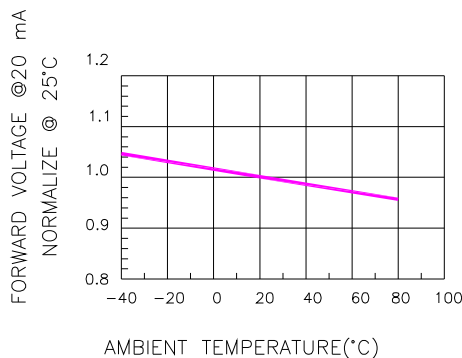

Fig.3 FORWARD VOLTAGE VS. TEMPERATURE

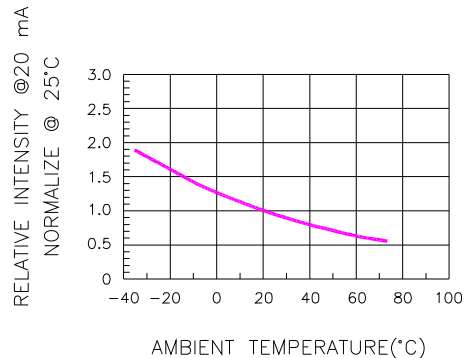

Fig.4 RELATIVE INTENSITY VS. TEMPERATURE

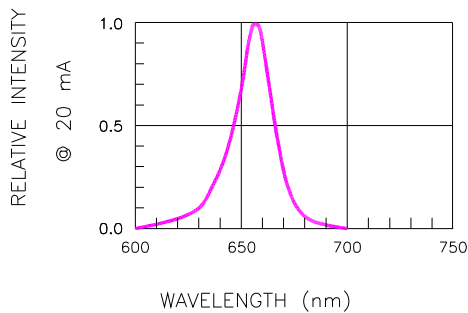

Fig.5 RELATIVE INTENSITY VS. WAVELENGTH

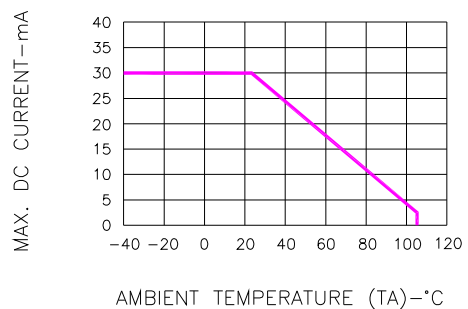

Fig.6 MAX. ALLOWABLE DC CURRENT VS. AMBIENT TEMPERATURE



Opto Plus LED Corp.
1.0" Case Mold Type LED Display
OPD-S10010LR-BW
OPD-S10011LR-BW

● **RECOMMEND SOLDERING PROFILE**



● **SOLDERING IRON**

Basic spec is ≤ 4 sec when 260°C. If temperature is higher, time should be shorter (+10°C→1 sec). Power dissipation of Iron should be smaller than 15W, and temperature should be controllable. Surface temperature of the device should be under 230°C.

● **REWORK**

Customer must finish rework within ≤ 4 sec under 245°C.