



Opto Plus LED Corp.
1.2” 5 x 7 Dot Matrix LED Display
OPD-M35720LY-GW
OPD-M35721LY-GW

● **FEATURES**

- 1.2 inch (30.42 mm) Matrix Height.
- Stackable vertically and horizontally.
- 5x7 array with X-Y select.
- Wide viewing angle.
- Gray face, White dot.
- Case mold type.
- RoHS compliant, Pb Free.

● **DESCRIPTION**

The OPD-M35720LY-GW & OPD-M35721LY-GW is a 1.2 inch (30.42 mm) 5x7 dot matrix display.

This device utilizes Super Bright Yellow LED chip which are made from AlGaInP on a transparent GaAs, substrate. The display has Gray face, White dot.

● **DEVICE**

PART NO	DESCRIPTION
Super Bright Yellow	
OPD-M35720LY-GW	Anode Column Cathode Row
OPD-M35721LY-GW	Anode Row Cathode Column

RoHS Compliance



Pb free.





Opto Plus LED Corp.

1.2" 5 x 7 Dot Matrix LED Display

OPD-M35720LY-GW

OPD-M35721LY-GW

● MECHANICAL DIMENSIONS

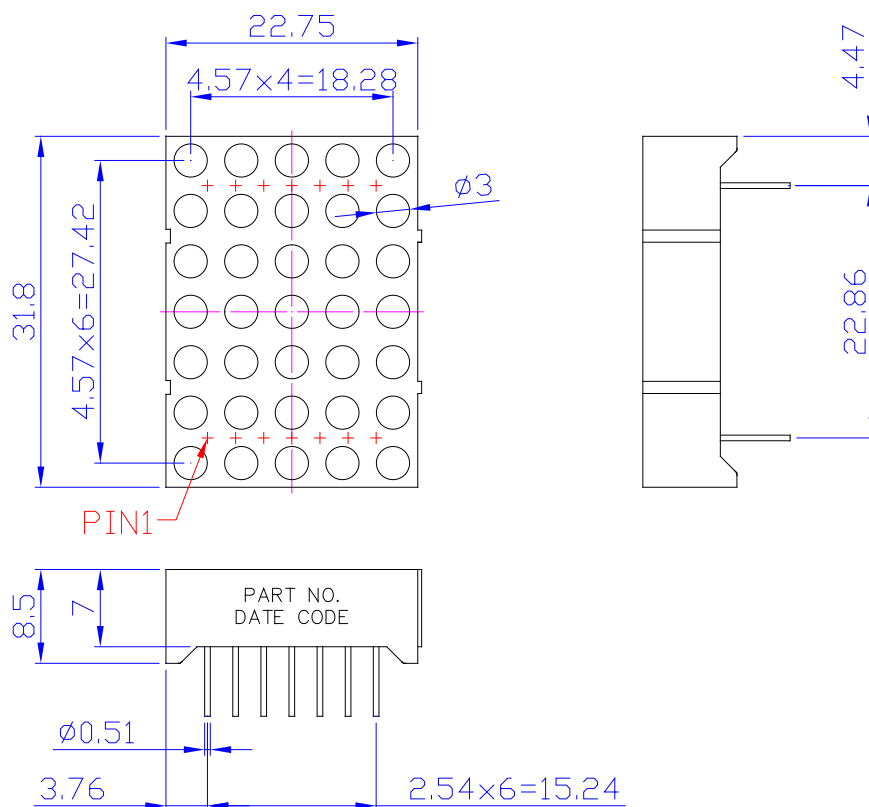

NOTES: All dimensions are in millimeters. Tolerances are ± 0.25 mm unless otherwise noted.

● TYPICAL INTERNAL EQUIVALENT CIRCUIT

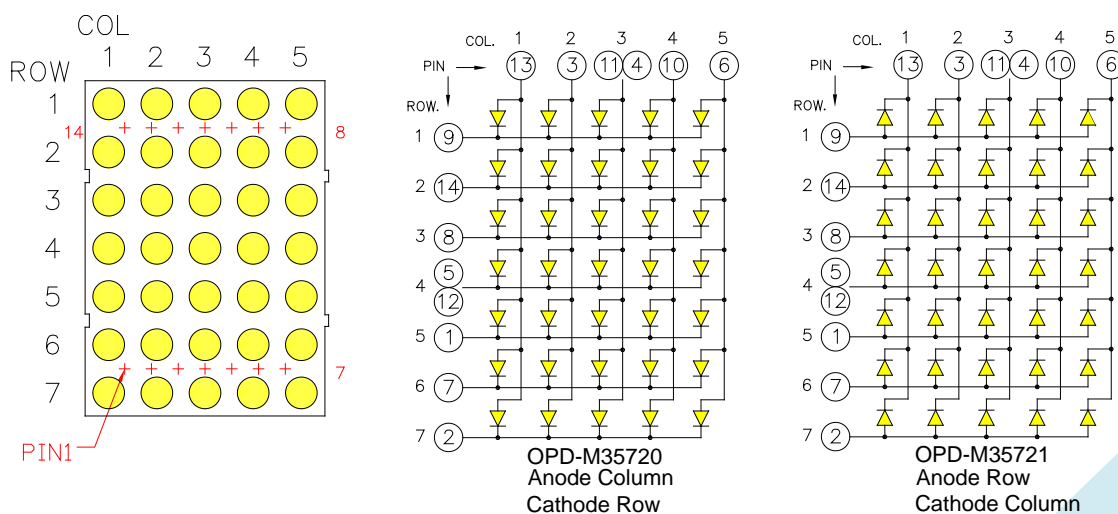



Opto Plus LED Corp.
1.2" 5 x 7 Dot Matrix LED Display
OPD-M35720LY-GW
OPD-M35721LY-GW

● **LY: SUPER BRIGHT YELLOW (AlGaInP/GaAs)**

ABSOLUTE MAXIMUM RATING AT Ta=25°C

Parameter	Symbol	Super Bright Yellow	Unit
Power dissipation per dice	P _{AD}	70	mW
Derating liner from 25°C per dice	-	0.28	mA / °C
Continuous forward current per dice	I _{AF}	25	mA
Peak current per dice (duty cycle 1/10, 1kHz)	I _{PF}	90	mA
Reverse voltage per dice	V _R	5	V
Operating temperature	T _{OPR}	-25 to +85	°C
Storage temperature	T _{STG}	-25 to +85	°C

ELECTRICAL - OPTICAL CHARACTERISTICS AT Ta=25°C

Characteristic	Symbol	Condition	Min.	Typ.	Max.	Unit
Forward voltage	V _F	I _F =20mA	-	2.0	2.6	V
Reverse current	I _R	V _R =5V	-	-	10	μA
Peak wavelength	λ _P	I _F =20mA	-	593	-	nm
Dominant wavelength	λ _D	I _F =20mA	-	590	-	nm
Luminous intensity	I _V	I _F =20mA	-	60	-	mcd
Spectral radiation bandwidth	Δλ	I _F =20mA	-	20	-	nm



Opto Plus LED Corp.

1.2" 5 x 7 Dot Matrix LED Display

OPD-M35720LY-GW

OPD-M35721LY-GW

● LY: SUPER BRIGHT YELLOW (AlGaInP/GaAs) CURVE

Typical Electro-optical Characteristic Curves (25 °C Free Air Temperature Unless Otherwise Specified)

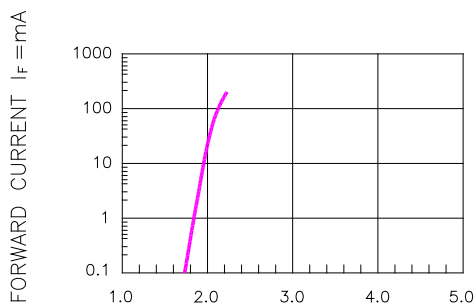

Fig.1 FORWARD CURRENT VS. FORWARD VOLTAGE

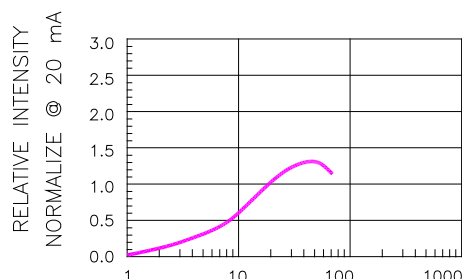

Fig.2 RELATIVE INTENSITY VS. FORWARD CURRENT

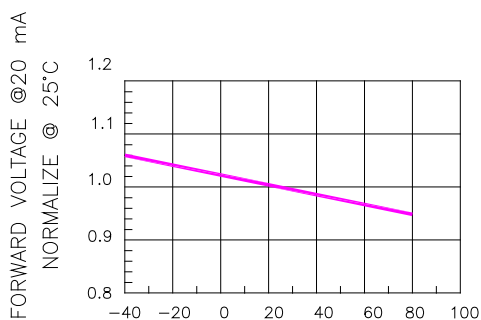

Fig.3 FORWARD VOLTAGE VS. TEMPERATURE

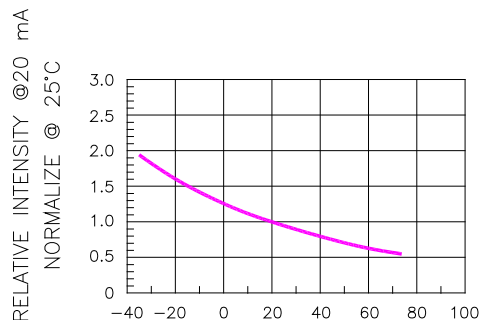

Fig.4 RELATIVE INTENSITY VS. TEMPERATURE

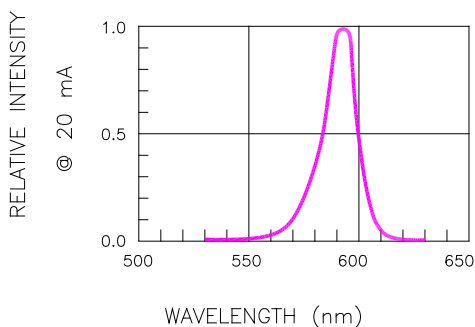

Fig.5 RELATIVE INTENSITY VS. WAVELENGTH

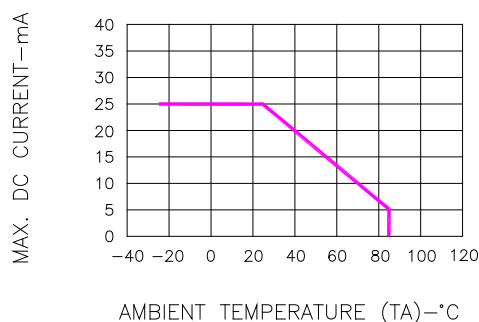

Fig.6 MAX. ALLOWABLE DC CURRENT VS. AMBIENT TEMPERATURE



Opto Plus LED Corp.

1.2" 5 x 7 Dot Matrix LED Display

OPD-M35720LY-GW

OPD-M35721LY-GW

● RECOMMEND SOLDERING PROFILE



● SOLDERING IRON

Basic spec is ≤ 4 sec when 260°C. If temperature is higher, time should be shorter (+10°C → 1 sec). Power dissipation of Iron should be smaller than 15W, and temperature should be controllable. Surface temperature of the device should be under 230°C.

● REWORK

Customer must finish rework within ≤ 4 sec under 245°C.