



**Opto Plus LED Corp.**  
**0.3" Case Mold Type LED Display**  
**OPD-D3610UPG-BW**  
**OPD-D3611UPG-BW**

● **FEATURES**

- 0.36inch (9.2 mm) Digit Height.
- Low current operation.
- Case mold type.
- Black face, White segment.
- RoHS compliant, Pb Free.

● **DESCRIPTION**

The OPD-D3610UPG-BW & OPD-D3611UPG-BW is a 0.36 inch (9.2 mm) height dual digits display.

This device utilizes Pure Green LED chip which are made from InGaN on a transparent GaN. The display has Black face, White segment.

● **DEVICE**

<b>PART NO</b> Pure Green	<b>DESCRIPTION</b>
OPD-D3610UPG-BW	Common Anode
OPD-D3611UPG-BW	Common Cathode

**RoHS Compliance**



**Pb free.**





# Opto Plus LED Corp.

## 0.3" Case Mold Type LED Display

### OPD-D3610UPG-BW

### OPD-D3611UPG-BW

### ● MECHANICAL DIMENSIONS

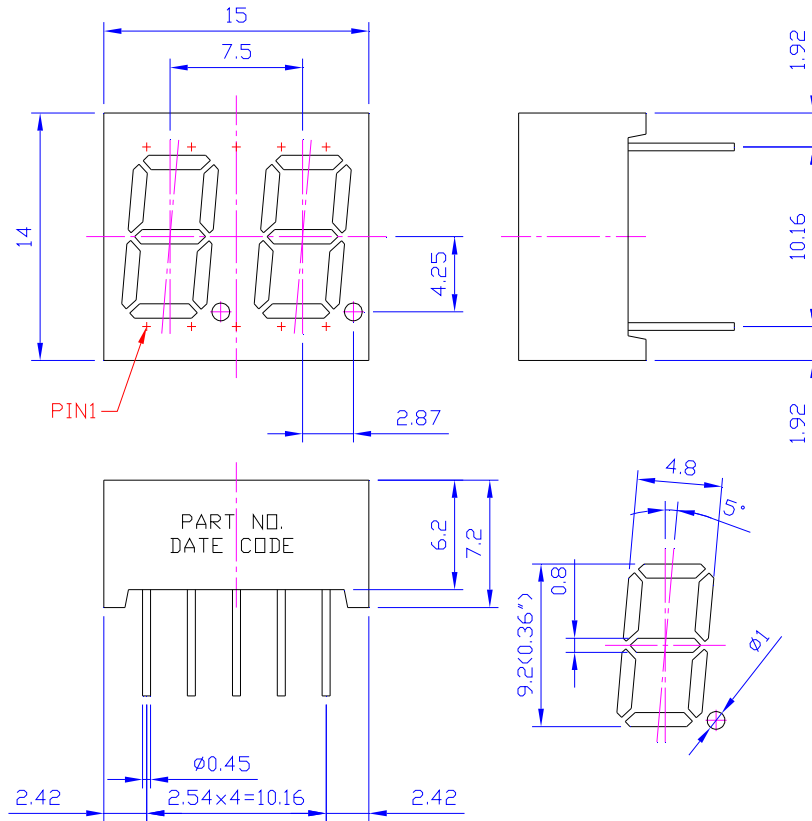

NOTES: All dimensions are in millimeters. Tolerances are  $\pm 0.25$  mm unless otherwise noted.

### ● TYPICAL INTERNAL EQUIVALENT CIRCUIT

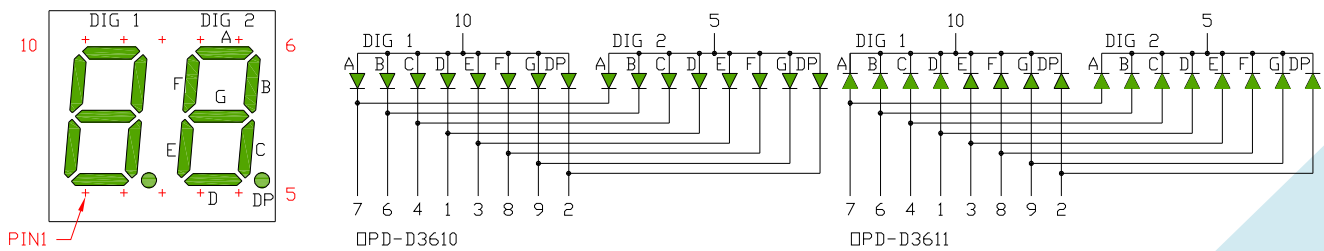



**Opto Plus LED Corp.**  
**0.3" Case Mold Type LED Display**  
**OPD-D3610UPG-BW**  
**OPD-D3611UPG-BW**

● **PG: PURE GREEN (InGaN/GaN)**

ABSOLUTE MAXIMUM RATING AT Ta=25°C

Parameter	Symbol	Pure Green	Unit
Power dissipation per dice	P <sub>AD</sub>	120	mW
Derating liner from 25°C per dice	-	0.3	mA / °C
Continuous forward current per dice	I <sub>AF</sub>	30	mA
Peak current per dice (duty cycle 1/10, 1kHz)	I <sub>PF</sub>	100	mA
Reverse voltage per dice	V <sub>R</sub>	5	V
Operating temperature	T <sub>OPR</sub>	-25 to +85	°C
Storage temperature	T <sub>STG</sub>	-25 to +85	°C

ELECTRICAL - OPTICAL CHARACTERISTICS AT Ta=25°C

Characteristic	Symbol	Condition	Min.	Typ.	Max.	Unit
Forward voltage	V <sub>F</sub>	I <sub>F</sub> =20mA	-	3.2	4.0	V
Reverse current	I <sub>R</sub>	V <sub>R</sub> =8V	-	-	10	μA
Dominant wavelength	λ <sub>D</sub>	I <sub>F</sub> =20mA	-	525	-	nm
Luminous intensity	I <sub>v</sub>	I <sub>F</sub> =20mA	-	140	-	mcd
Spectral radiation bandwidth	Δλ	I <sub>F</sub> =20mA	-	30	-	nm



# Opto Plus LED Corp.

## 0.3" Case Mold Type LED Display

### OPD-D3610UPG-BW

### OPD-D3611UPG-BW

#### ● PG: PURE GREEN (InGaN/GaN) CURVE

Typical Electro-optical Characteristic Curves  
(25 °C Free Air Temperature Unless Otherwise Specified)

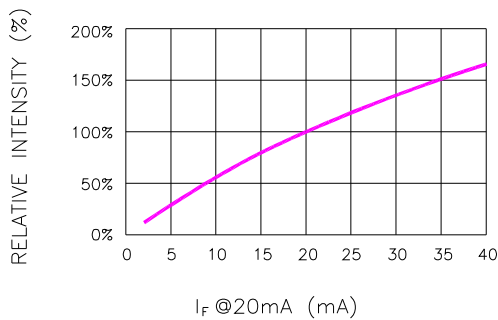

Fig.1 RELATIVE INTENSITY VS. FORWARD CURRENT

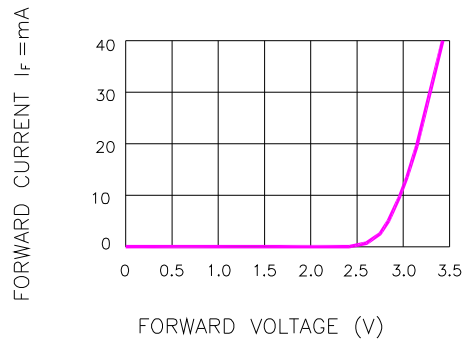

Fig.2 FORWARD CURRENT VS. FORWARD VOLTAGE

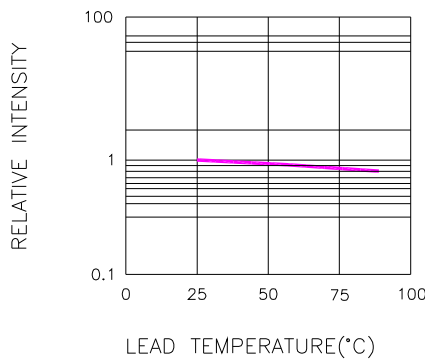

Fig.3 RELATIVE INTENSITY VS. LEAD TEMPERATURE  
(PULSED 20 mA; 300us PULSE, 10ms PERIOD)

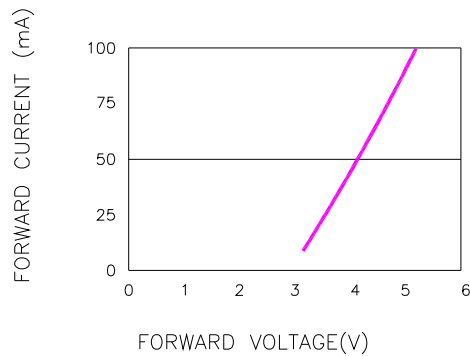

Fig.4 PEAK FORWARD VOLTAGE VS. FORWARD (100us TEST PULSE, 1% DUTY CYCLE)

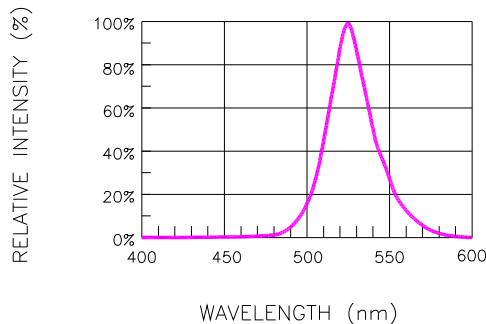

Fig.5 RELATIVE INTENSITY VS. WAVELENGTH

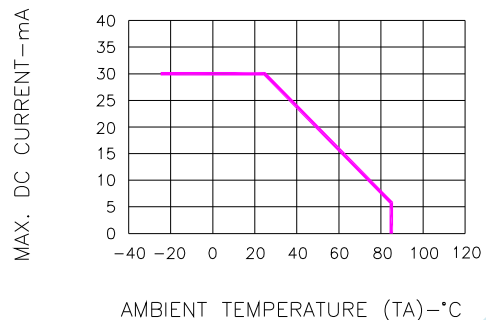

Fig.6 MAX. ALLOWABLE DC CURRENT VS. AMBIENT TEMPERATURE



**Opto Plus LED Corp.**  
**0.3" Case Mold Type LED Display**  
**OPD-D3610UPG-BW**  
**OPD-D3611UPG-BW**

● **RECOMMEND SOLDERING PROFILE**



● **SOLDERING IRON**

Basic spec is  $\leq 4$  sec when 260°C. If temperature is higher, time should be shorter (+10°C→1 sec). Power dissipation of Iron should be smaller than 15W, and temperature should be controllable. Surface temperature of the device should be under 230°C.

● **REWORK**

Customer must finish rework within  $\leq 4$  sec under 245°C.