



Opto Plus LED Corp.
0.36" Case Mold Type LED Display
OPD-D3610LB-BW
OPD-D3611LB-BW

● **FEATURES**

- 0.36 inch (9.2 mm) Digit Height.
- Low current operation.
- Case mold type.
- Black face, White segment.
- RoHS compliant, Pb Free.

● **DESCRIPTION**

The OPD-D3610LB-BW & OPD-D3611LB-BW is a 0.36 inch (9.2 mm) height dual digits display.

This device utilizes Super Bright Blue LED chip which are made from InGaN on a transparent GaN substrate. The display has Black face, White segment..

● **DEVICE**

PART NO	DESCRIPTION
Super Bright Blue	
OPD-D3610LB-BW	Common Anode
OPD-D3611LB-BW	Common Cathode

RoHS Compliance



Pb free.





Opto Plus LED Corp.

0.36" Case Mold Type LED Display

OPD-D3610LB-BW

OPD-D3611LB-BW

● MECHANICAL DIMENSIONS

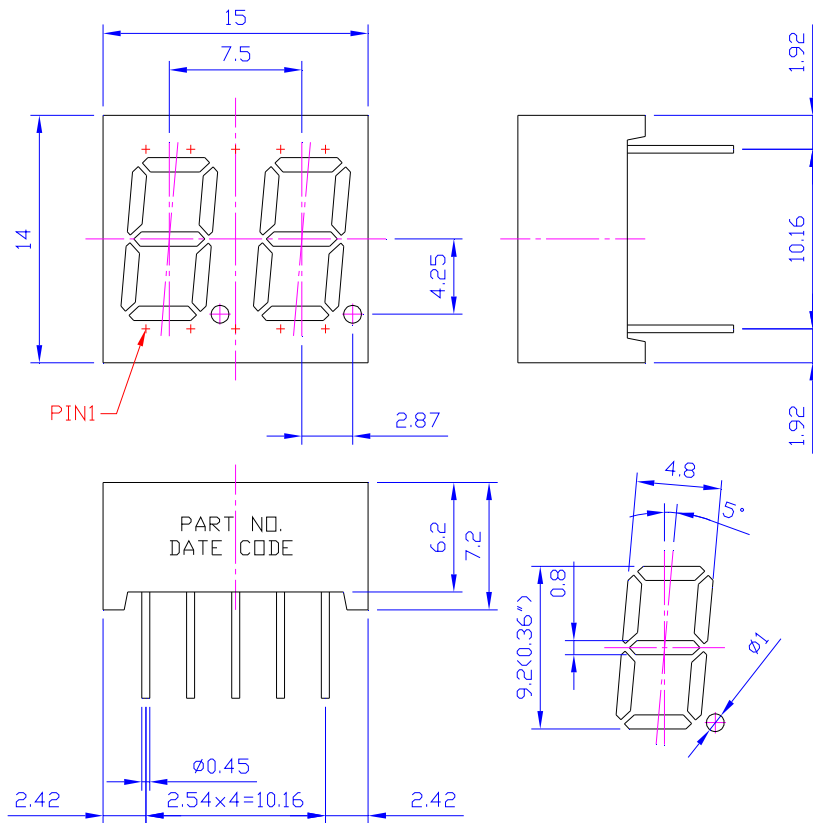

NOTES: All dimensions are in millimeters. Tolerances are ± 0.25 mm unless otherwise noted.

● TYPICAL INTERNAL EQUIVALENT CIRCUIT

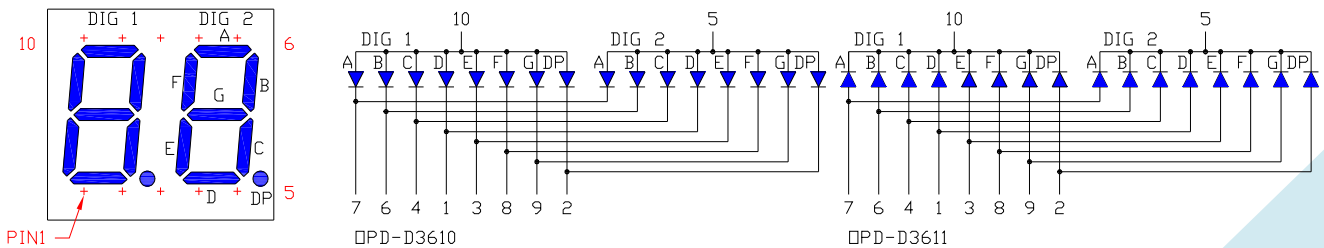



Opto Plus LED Corp.
0.36'' Case Mold Type LED Display
OPD-D3610LB-BW
OPD-D3611LB-BW

● **LB: SUPER BRIGHT BLUE (InGaN/GaN)**

ABSOLUTE MAXIMUM RATING AT $T_a=25^{\circ}\text{C}$

Parameter	Symbol	Super Bright Blue	Unit
Power dissipation per dice	P_{AD}	120	mW
Derating liner from 25 °C per dice	-	0.4	mA / °C
Continuous forward current per dice	I_{AF}	30	mA
Peak current per dice (duty cycle 1/10, 1kHz)	I_{PF}	100	mA
Reverse voltage per dice	V_R	5	V
Operating temperature	T_{OPR}	-25 to +85	°C
Storage temperature	T_{STG}	-25 to +85	°C

ELECTRICAL - OPTICAL CHARACTERISTICS AT $T_a=25^{\circ}\text{C}$

Characteristic	Symbol	Condition	Min.	Typ.	Max.	Unit
Forward voltage	V_F	$I_F = 20\text{mA}$	-	3.2	4.0	V
Reverse current	I_R	$V_R = 8\text{V}$	-	-	10	μA
Dominant wavelength	λ_D	$I_F = 20\text{mA}$	-	470	-	nm
Luminous intensity	I_V	$I_F = 20\text{mA}$	-	60	-	mcd
Spectral radiation bandwidth	$\Delta\lambda$	$I_F = 20\text{mA}$	-	30	-	nm

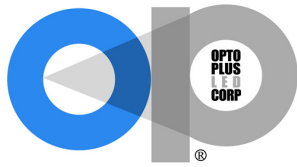

Opto Plus LED Corp.

0.36" Case Mold Type LED Display

OPD-D3610LB-BW

OPD-D3611LB-BW

● LB: SUPER BRIGHT BLUE (InGaN/GaN) CURVE

Typical Electro-optical Characteristic Curves
(25 °C Free Air Temperature Unless Otherwise Specified)

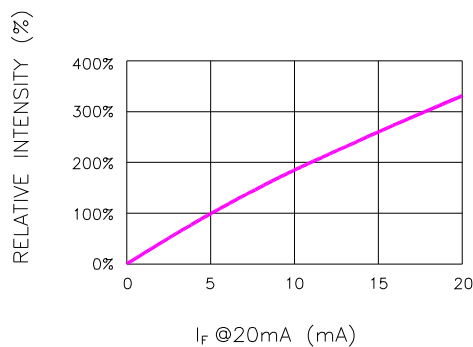

Fig.1 RELATIVE INTENSITY VS. FORWARD CURRENT

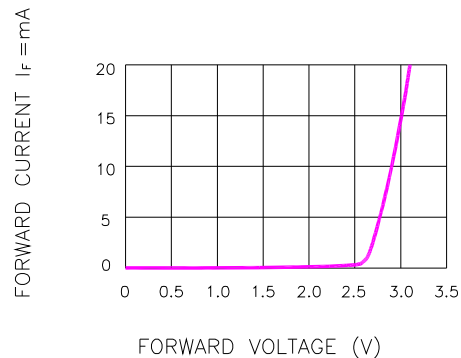

Fig.2 FORWARD CURRENT VS. FORWARD VOLTAGE

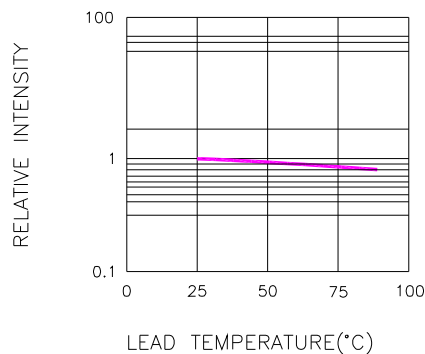

Fig.3 RELATIVE INTENSITY VS. LEAD TEMPERATURE
(PULSED 20 mA; 300us PULSE, 10ms PERIOD)

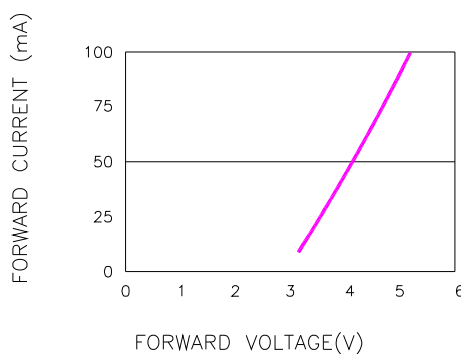

Fig.4 PEAK FORWARD VOLTAGE VS. FORWARD (100us TEST PULSE, 1% DUTY CYCLE)

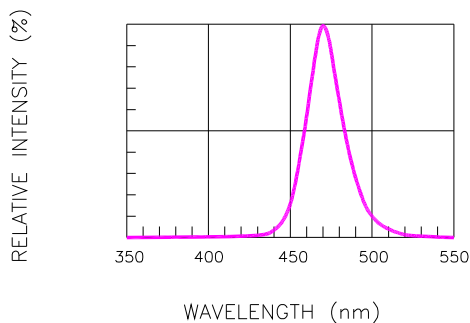

Fig.5 RELATIVE INTENSITY VS. WAVELENGTH

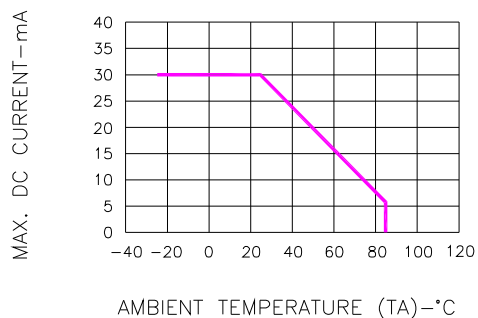

Fig.6 MAX. ALLOWABLE DC CURRENT VS. AMBIENT TEMPERATURE



Opto Plus LED Corp.
0.36" Case Mold Type LED Display
OPD-D3610LB-BW
OPD-D3611LB-BW

● **RECOMMEND SOLDERING PROFILE**



● **SOLDERING IRON**

Basic spec is ≤ 4 sec when 260°C. If temperature is higher, time should be shorter (+10°C→1 sec). Power dissipation of Iron should be smaller than 15W, and temperature should be controllable. Surface temperature of the device should be under 230°C.

● **REWORK**

Customer must finish rework within ≤ 4 sec under 245°C.