



**Opto Plus LED Corp.**  
**0.53" Case Mold Type LED Display**  
**OPD-AD5330LR-GW**  
**OPD-AD5331LR-GW**

● **EDIT HISTORY**

Version A: Mar. 6, 2013

Preliminary Spec.

Version B: Sep. 25, 2015

Add package dimensions.

Manufacture	Examination	Approving



**Opto Plus LED Corp.**  
**0.53" Case Mold Type LED Display**  
**OPD-AD5330LR-GW**  
**OPD-AD5331LR-GW**

● **FEATURES**

- 0.53 inch (13.60 mm) Digit Height.
- Low current operation.
- Case mold type.
- Gray face, White segment.
- RoHS compliant, Pb Free.

● **DESCRIPTION**

The OPD-AD5330LR-GW & OPD-AD5331LR-GW is a 0.53 inch (13.60mm) height dual digits display.

This device utilizes Super Red LED chip which are made from AlGaInP on a transparent GaAs substrate. The display has Gray face, White segment.

● **DEVICE**

<b>PART NO Super Red</b>	<b>DESCRIPTION</b>
OPD-AD5330LR-GW	Common Anode
OPD-AD5331LR-GW	Common Cathode

**RoHS Compliance**



**Pb free.**





# Opto Plus LED Corp.

## 0.53" Case Mold Type LED Display

### OPD-AD5330LR-GW

### OPD-AD5331LR-GW

### MECHANICAL DIMENSIONS

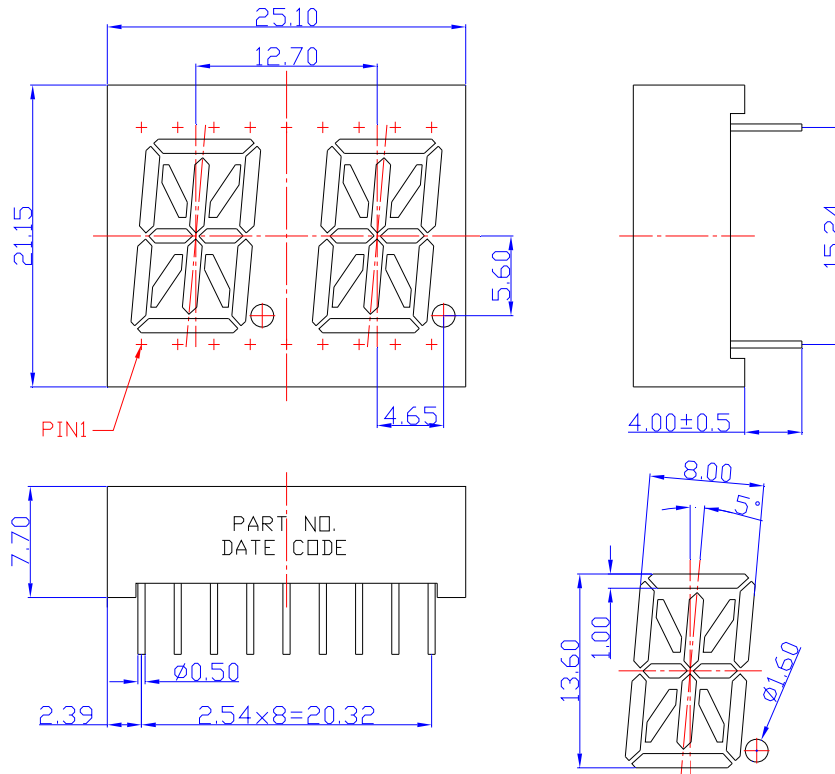

NOTES: All dimensions are in millimeters. Tolerances are  $\pm 0.25$  mm unless otherwise noted.

### TYPICAL INTERNAL EQUIVALENT CIRCUIT

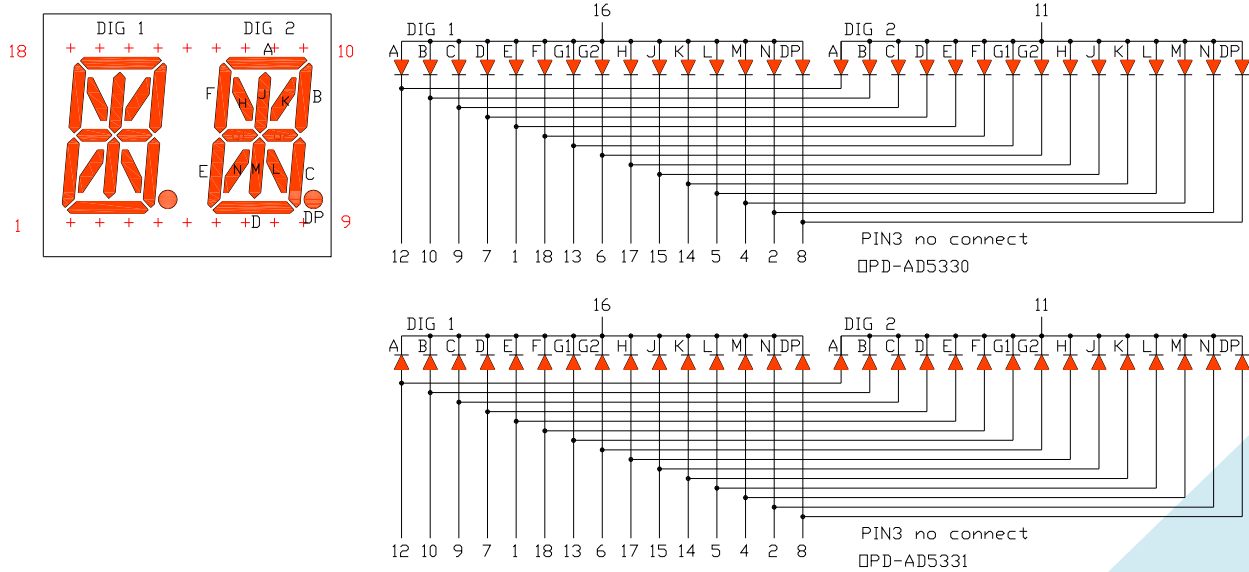



**Opto Plus LED Corp.**  
**0.53" Case Mold Type LED Display**  
**OPD-AD5330LR-GW**  
**OPD-AD5331LR-GW**

● **LR: SUPER RED (AlGaInP/GaAs)**

ABSOLUTE MAXIMUM RATING AT Ta=25°C

Parameter	Symbol	Super Red	Unit
Power dissipation per dice	P <sub>AD</sub>	70	mW
Derating liner from 25°C per dice	-	0.33	mA / °C
Continuous forward current per dice	I <sub>AF</sub>	25	mA
Peak current per dice (duty cycle 1/10, 1kHz)	I <sub>PF</sub>	90	mA
Reverse voltage per dice	V <sub>R</sub>	5	V
Operating temperature	T <sub>OPR</sub>	-25 to +85	°C
Storage temperature	T <sub>STG</sub>	-25 to +85	°C

ELECTRICAL - OPTICAL CHARACTERISTICS AT Ta=25°C

Characteristic	Symbol	Condition	Min.	Typ.	Max.	Unit
Forward voltage	V <sub>F</sub>	I <sub>F</sub> =20mA	-	2.0	2.6	V
Reverse current	I <sub>R</sub>	V <sub>R</sub> =5V	-	-	10	μA
Peak wavelength	λ <sub>P</sub>	I <sub>F</sub> =20mA	-	650	-	nm
Dominant wavelength	λ <sub>D</sub>	I <sub>F</sub> =20mA	-	639	-	nm
Luminous intensity	I <sub>v</sub>	I <sub>F</sub> =20mA	-	30	-	mcd
Spectral radiation bandwidth	Δλ	I <sub>F</sub> =20mA	-	20	-	nm



# Opto Plus LED Corp.

## 0.53" Case Mold Type LED Display

### OPD-AD5330LR-GW

### OPD-AD5331LR-GW

#### ● LR: SUPER RED (AlGaInP/GaAs)

Typical Electro-optical Characteristic Curves  
(25 °C Free Air Temperature Unless Otherwise Specified)

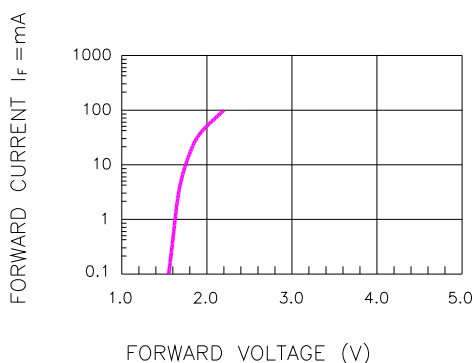

Fig.1 FORWARD CURRENT VS. FORWARD VOLTAGE

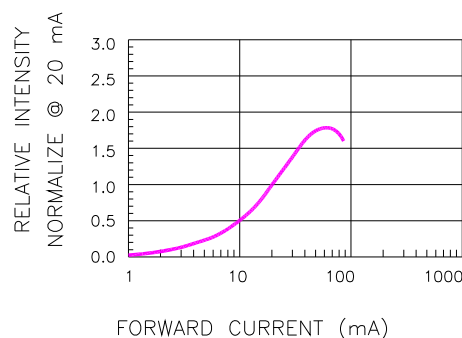

Fig.2 RELATIVE INTENSITY VS. FORWARD CURRENT

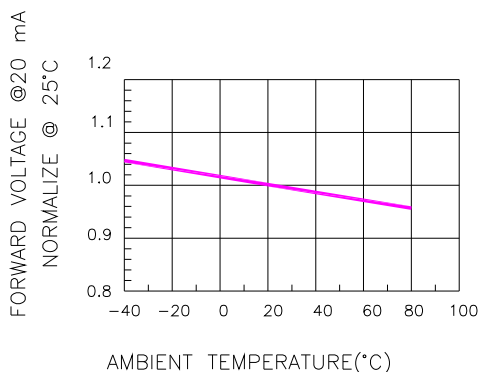

Fig.3 FORWARD VOLTAGE VS. TEMPERATURE

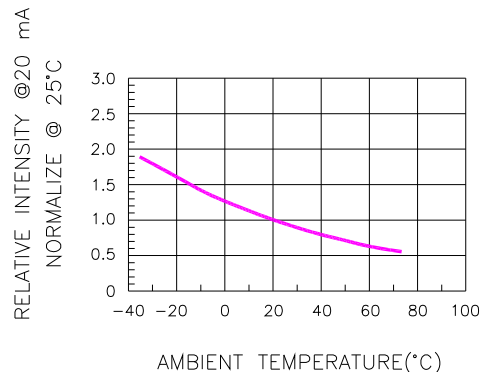

Fig.4 RELATIVE INTENSITY VS. TEMPERATURE

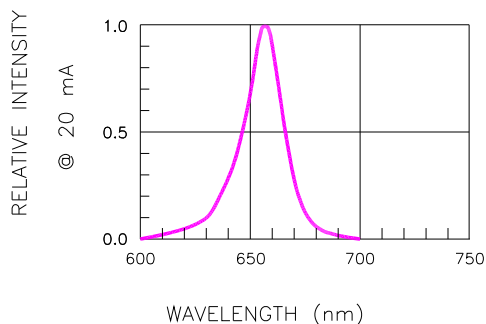

Fig.5 RELATIVE INTENSITY VS. WAVELENGTH

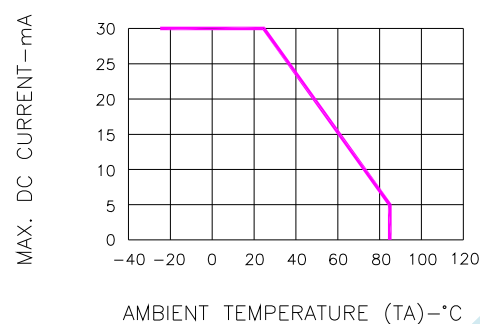
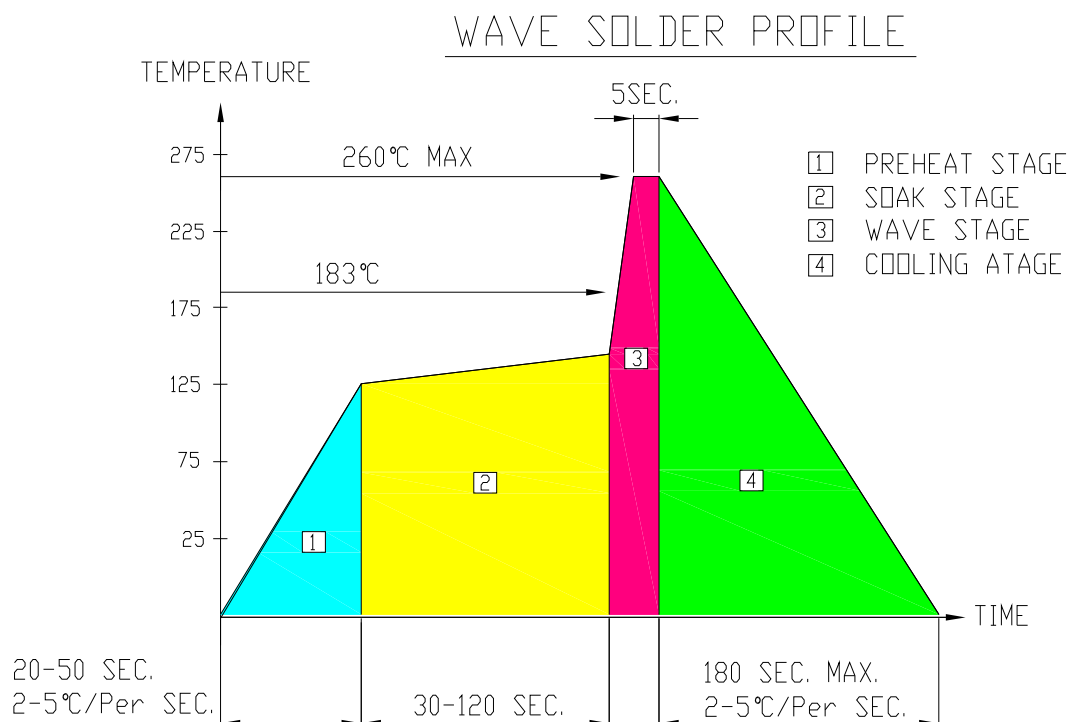

Fig.6 MAX. ALLOWABLE DC CURRENT VS. AMBIENT TEMPERATURE



**Opto Plus LED Corp.**  
**0.53" Case Mold Type LED Display**  
**OPD-AD5330LR-GW**  
**OPD-AD5331LR-GW**

● **RECOMMEND SOLDERING PROFILE**



● **Note:**

- Recommend pre-heat temperature of 105°C or less (as measured with a thermocouple attached to the LED pins) prior to immersion in the solder wave with a maximum solder bath temperature of 260°C
- Peak wave soldering temperature between 245°C ~ 225°C for 3 sec (5 sec max)
- No more than one wave soldering pass

● **SOLDERING IRON**

Basic spec is  $\leq 4$  sec when 260°C. If temperature is higher, time should be shorter (+10°C→1 sec). Power dissipation of Iron should be smaller than 15W, and temperature should be controllable. Surface temperature of the device should be under 230°C.

● **REWORK**

Customer must finish rework within  $\leq 3$  sec under 350°C.  
The head of soldering iron cannot touch copper foil.



**Opto Plus LED Corp.**  
**0.53" Case Mold Type LED Display**  
**OPD-AD5330LR-GW**  
**OPD-AD5331LR-GW**

● **PACKAGE DIMENSIONS**

168 PCS( 14X12) / 1 Polyform

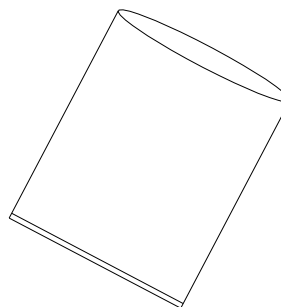
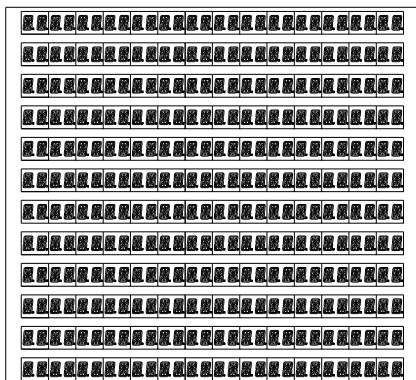

BAG SIZE :450X410X560

5 Polyform / 1BAG  
 840 PCS /1Inner Carton

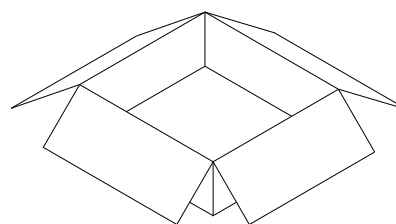

INNER BOX SIZE : 394 x 370 x 138 mm

1680 PCS / 2 Inner Carton / 1 Outer Carton

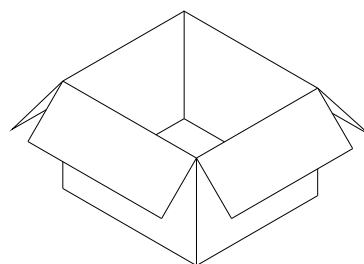

OUTER BOX SIZE : 430 x 390 x 300 mm

● **Note:**

**LED DISPLAY STANDARD STORAGED CONDITION**

Product in the original packaging material state is the recommended storage conditions.

TERATURE CONDITION	HUMIDITY CONDITION
5°C ~ 30°C	Below 60%RH

If the storage conditions do not meet specification standards, the component pins may become oxidized requiring re-plating and re-sorting before use. Suggest customers consume LEDs as soon as possible, and avoid long-term storage of large inventories.