



**Opto Plus LED Corp.**  
**0.53" Case Mold Type LED Display**  
**OPD-AD5330LB-3.5-GW**  
**OPD-AD5331LB-3.5-GW**

● **EDIT HISTORY**

Version A: Oct.28, 2014

Preliminary Spec.

Version B: Sep. 25, 2015

Add package dimensions.

Manufacture	Examination	Approving



**Opto Plus LED Corp.**  
**0.53" Case Mold Type LED Display**  
**OPD-AD5330LB-3.5-GW**  
**OPD-AD5331LB-3.5-GW**

● **FEATURES**

- 0.53 inch (13.60 mm) Digit Height.
- Low current operation.
- Case mold type.
- Gray face, White segment.
- RoHS compliant, Pb Free.

● **DESCRIPTION**

The OPD-AD5330LB-3.5-GW & OPD-AD5331LB-3.5-GW is a 0.53 inch (13.60 mm) height alphanumeric display.

This device utilizes super bright blue LED chip which are made from InGaN on a transparent GaN substrate. The display has Gray face, White segment.

● **DEVICE**

<b>PART NO</b> <b>Super Bright Blue</b>	<b>DESCRIPTION</b>
OPD-AD5330LB-3.5-GW	Common Anode
OPD-AD5331LB-3.5-GW	Common Cathode

**RoHS Compliance**



**Pb free.**





# Opto Plus LED Corp.

## 0.53" Case Mold Type LED Display

### OPD-AD5330LB-3.5-GW

### OPD-AD5331LB-3.5-GW

#### MECHANICAL DIMENSIONS

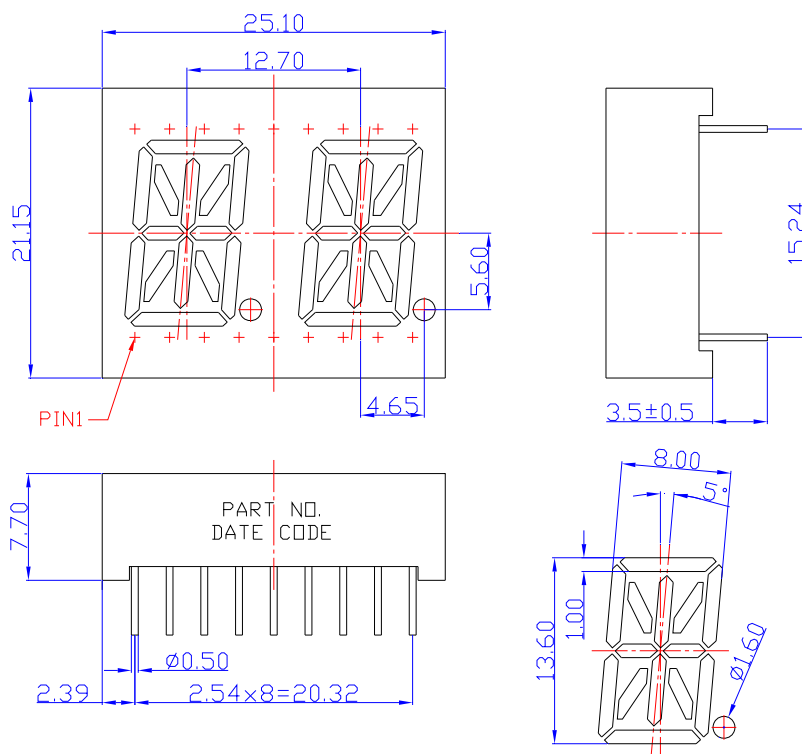

NOTES: All dimensions are in millimeters. Tolerances are ± 0.25 mm unless otherwise noted.

#### TYPICAL INTERNAL EQUIVALENT CIRCUIT

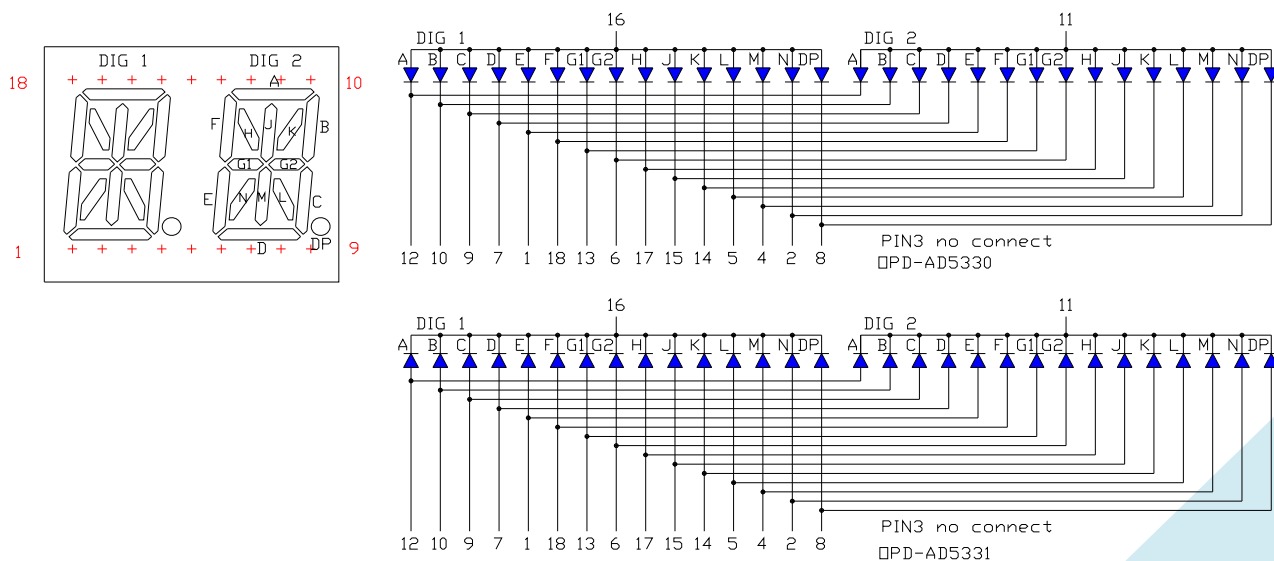



**Opto Plus LED Corp.**  
**0.53" Case Mold Type LED Display**  
**OPD-AD5330LB-3.5-GW**  
**OPD-AD5331LB-3.5-GW**

● **LB: SUPER BRIGHT BLUE (InGaN/GaN)**

ABSOLUTE MAXIMUM RATING AT Ta=25°C

Parameter	Symbol	Super Bright Blue	Unit
Power dissipation per dice	P <sub>AD</sub>	120	mW
Derating liner from 25°C per dice	-	0.4	mA / °C
Continuous forward current per dice	I <sub>AF</sub>	30	mA
Peak current per dice (duty cycle 1/10, 1kHz)	I <sub>PF</sub>	100	mA
Reverse voltage per dice	V <sub>R</sub>	5	V
Operating temperature	T <sub>OPR</sub>	-25 to +85	°C
Storage temperature	T <sub>STG</sub>	-25 to +85	°C

ELECTRICAL - OPTICAL CHARACTERISTICS AT Ta=25°C

Characteristic	Symbol	Condition	Min.	Typ.	Max.	Unit
Forward voltage	V <sub>F</sub>	I <sub>F</sub> =20mA	-	3.0	4.0	V
Reverse current	I <sub>R</sub>	V <sub>R</sub> =8V	-	-	10	μA
Dominant wavelength	λ <sub>D</sub>	I <sub>F</sub> =20mA	460	465	470	nm
Luminous intensity	I <sub>v</sub>	I <sub>F</sub> =20mA	-	40	-	mcd
Spectral radiation bandwidth	Δλ	I <sub>F</sub> =20mA	-	30	-	nm



# Opto Plus LED Corp.

## 0.53" Case Mold Type LED Display

### OPD-AD5330LB-3.5-GW

### OPD-AD5331LB-3.5-GW

#### ● LB: SUPER BRIGHT BLUE (InGaN/GaN) CURVE

Typical Electro-optical Characteristic Curves  
(25 °C Free Air Temperature Unless Otherwise Specified)

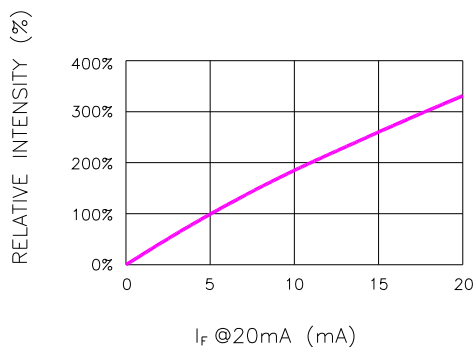

Fig.1 RELATIVE INTENSITY VS. FORWARD CURRENT

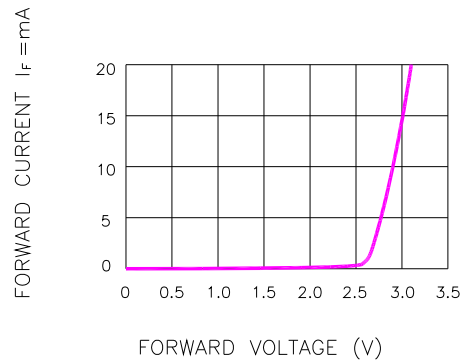

Fig.2 FORWARD CURRENT VS. FORWARD VOLTAGE

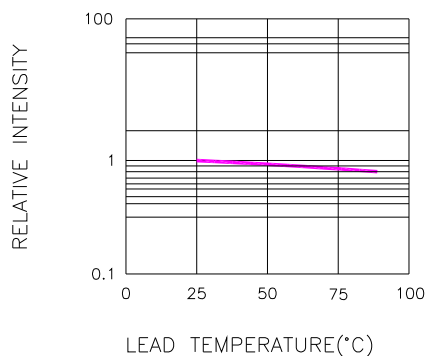

Fig.3 RELATIVE INTENSITY VS. LEAD TEMPERATURE  
(PULSED 20 mA; 300us PULSE, 10ms PERIOD)

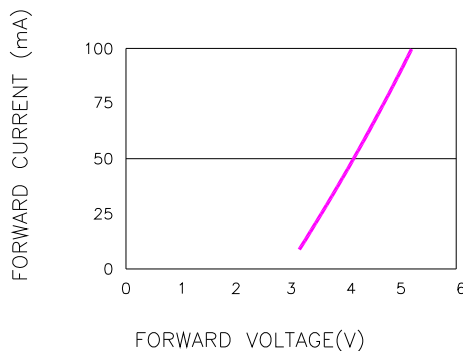

Fig.4 PEAK FORWARD VOLTAGE VS. FORWARD (100us TEST PULSE, 1% DUTY CYCLE)

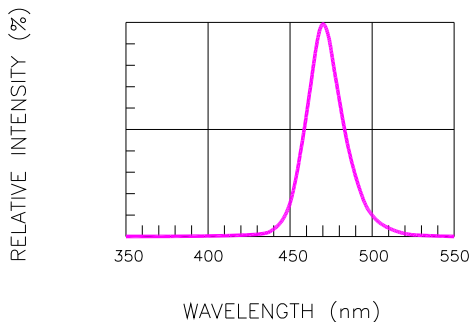

Fig.5 RELATIVE INTENSITY VS. WAVELENGTH

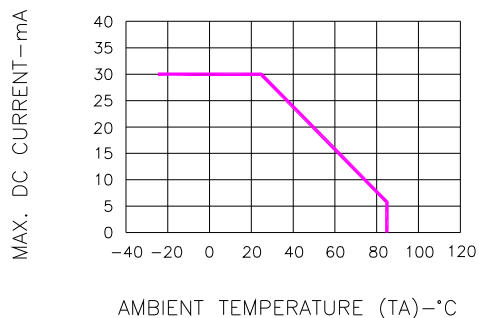
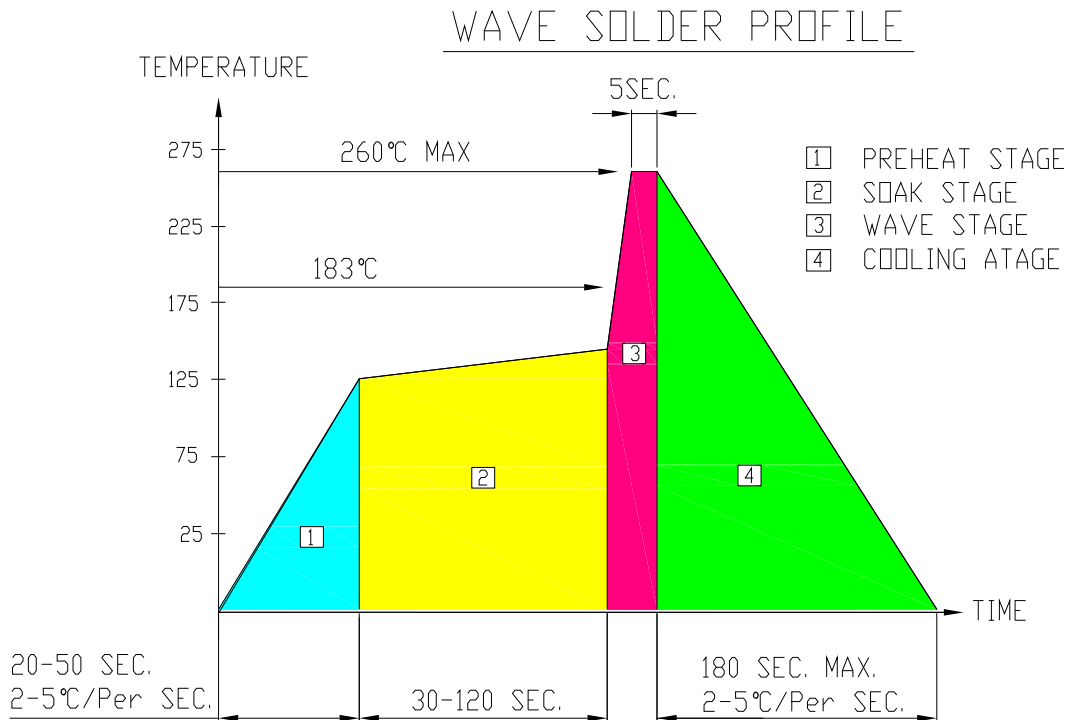

Fig.6 MAX. ALLOWABLE DC CURRENT VS. AMBIENT TEMPERATURE



**Opto Plus LED Corp.**  
**0.53" Case Mold Type LED Display**  
**OPD-AD5330LB-3.5-GW**  
**OPD-AD5331LB-3.5-GW**

● **RECOMMEND SOLDERING PROFILE**



● **Note:**

- Recommend pre-heat temperature of 105°C or less (as measured with a thermocouple attached to the LED pins) prior to immersion in the solder wave with a maximum solder bath temperature of 260°C
- Peak wave soldering temperature between 245°C ~ 225°C for 3 sec (5 sec max)
- No more than one wave soldering pass

● **SOLDERING IRON**

Basic spec is  $\leq 4$  sec when 260°C. If temperature is higher, time should be shorter (+10°C→1 sec). Power dissipation of Iron should be smaller than 15W, and temperature should be controllable. Surface temperature of the device should be under 230°C.

● **REWORK**

Customer must finish rework within  $\leq 3$  sec under 350°C.  
The head of soldering iron cannot touch copper foil.



**Opto Plus LED Corp.**  
**0.53" Case Mold Type LED Display**  
**OPD-AD5330LB-3.5-GW**  
**OPD-AD5331LB-3.5-GW**

● **PACKAGE DIMENSIONS**

168 PCS( 14X12) / 1 Pink ESD Polyform

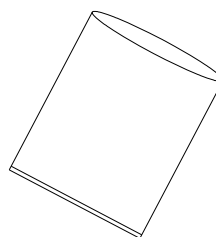
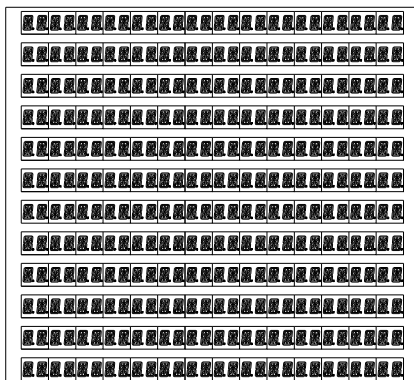

ESD BAG SIZE : 650 x 550 mm

5 Pink ESD Polyform / 1 Pink BAG  
 840 PCS /1Inner Carton

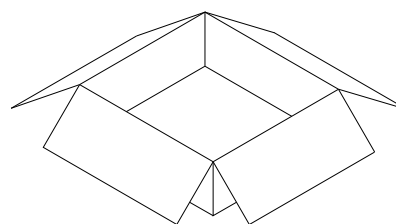

INNER BOX SIZE : 394 x 370 x 138 mm

1680 PCS / 2 Inner Carton / 1 Outer Carton

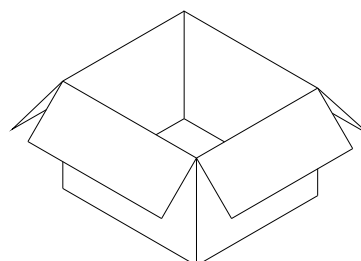

OUTER BOX SIZE : 430 x 390 x 300 mm

● **Note:**

**LED DISPLAY STANDARD STORAGED CONDITION**

Product in the original packaging material state is the recommended storage conditions.

TERATURE CONDITION	HUMIDITY CONDITION
5°C ~ 30°C	Below 60%RH

If the storage conditions do not meet specification standards, the component pins may become oxidized requiring re-plating and re-sorting before use. Suggest customers consume LEDs as soon as possible, and avoid long-term storage of large inventories.